

CATALOG

UNISTRUT®

APPLICATION SHOWCASE

Unistrut® Metal Framing • Telespar® & Telestrut® Telescopic Tube • Solar Installation Products
PrimeAngle® Slotted Angle System • United Interlock® Grating System

A PART OF



Product Introductions

Page 3



UNISTRUT® Metal Framing

Unistrut Metal Framing is the original strut system offering a time and money saving alternative to conventional support methods. The Unistrut system eliminates welding and drilling, and is easily adjustable, demountable and reusable.

Page 4



TELESPAR® Telescopic Tubing

Perforated, four-sided Telespar Telescopic Tubing makes quick work of hundreds of support applications, without special tools, welding or assembly. Self-aligning dimpled fittings and telescoping action provide fast assembly and repeatable, incremental adjustment.

Page 4



TELESTRUT® Telescopic Tubing

Telestrut is a perfect compliment to the Unistrut metal framing system. It's the only telescoping system that offers both infinite and incremental adjustability. Five connection methods include a boltless universal rivet that can cut assembly time in half.

Page 5



PRIME-ANGLE™ Slotted Angle System

PrimeAngle™ is a complete slotted angle support system that's versatile, economical and easy-to-use. With the standard 10' and 12' lengths, three strengths and two finishes, PrimeAngle meets a wide range of support needs and requires only a 9/16" wrench for assembly.

Page 5



UNITED INTERLOCK® Grating System

Engineered with a high strength-to-weight ratio, these multi-use planks can be carried by one person. United Interlock Grating installs easily with a snap-together friction fit that minimizes welding and bolting, providing overall cost savings of up to 60% over other materials.

Page 6

Storage Racks & Shelves

Page 7

Pipe & Conduit Supports

Page 8

Equipment, Tool & Sign Supports

Page 10

Ceiling Support Grids

Page 11

Cable Tray Supports

Page 12

Unipier® Rooftop Supports

Page 13

Material Handling

Page 14

Platforms, Tables & Risers

Page 15

Rooftop Walkways & Supports

Page 16

Integrated Office & Laboratory Components

Page 17

Solar Support Systems

Page 18

Medical Equipment Supports

Page 20

Product Pictorials

UNISTRUT® Metal Framing

Product Introductions

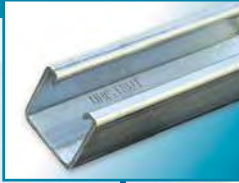

Look for this icon to identify Metal Framing applications throughout this brochure.

Unistrut Metal Framing is the original strut system offering a time and money saving alternative to conventional support methods. The Unistrut system eliminates welding and drilling, and is easily adjustable, demountable and reusable.



Featuring The Unique Unistrut Connection

- No Welding
- No Drilling
- 100% Adjustable
- 100% Reusable



Hex-head bolt threads easily into a spring nut, connecting fitting to channel in a quick one-hand operation.

When the nut is tightened against the inturned edges, the nut teeth create a vise-like grip, tying sides together in a strong "box" configuration,

Spring allows precision placement anywhere along channel length, then holds the nut in position while connection is completed.

Fifteen channel sizes and hundreds of fittings give you engineered solutions to a virtually limitless variety of projects.



1 Insert the spring nut anywhere along the continuous slotted channel. Rounded nut ends permit easy insertion.

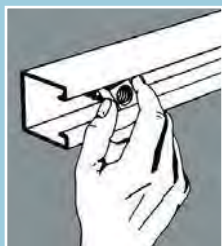

2 A 90° clockwise turn aligns the grooves in the nut with the inturned edges of the channel. Fittings can be placed anywhere along the channel opening.

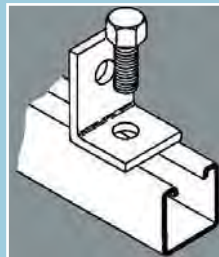

3 Insert bolt through fitting and into the spring nut.

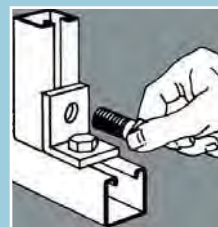

4 Additional channel sections can now be bolted to the fitting already in place by using steps 1-3.

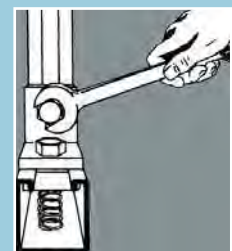

5 Tightening with a wrench locks the serrated teeth of the nut into the inturned edges of the channel, forming a strong, vise-like connection.

PRODUCT INTRODUCTIONS

TELESPAR® Telescopic Tubing

Product Introduction



■ Holes on 1" centers in telescoped sections remain in perfect alignment. Hole patterns on 1, 2, or 3 sides may be special ordered to meet your specific needs.



Look for this icon to identify Telespar applications throughout this brochure.

The engineered four-sided tubing system that carries a heavy load... 1,001 different ways.

Telespar Telescopic Tubing perforated sections are available in eight sizes from 1" to 2½" square. Perforated sections feature holes on all four sides, spaced on one-inch centers. Sections without holes are also available. Versatile, adjustable and reusable, Telespar Tubing offers design flexibility as well as important savings in time and labor costs.

Available in 10, 12 and 14 gauge steel, with a complete line of fittings, fasteners and accessories, Telespar lets you create new designs in hundreds of applications. From racks and interior partitions to adjustable platforms, hangers and sign supports, you can build them all without special welding, tools, or assembly skills.

TELESTRUT® Telescopic Tubing

Product Introduction



Look for this icon to identify Telestrut applications throughout this brochure.

Three-sided channel and four-sided tubing, working together in one powerful support system.



By joining infinitely-adjustable three-sided channel with incrementally adjustable, pre-punched four-sided tubing, the Telestrut system can be telescoped, spliced, adjusted and re-used faster and easier than anything in its class. So you can design, build and change support structures faster...and better...than you ever thought possible.

Efficient assembly with no welding, drilling or other time-consuming fabrication, plus five different fastening options...including a rivet system for super-fast boltless fastening... provides maximum project power. Other fasteners include the Unistrut spring nut and bolt, standard through-bolts and for temporary connections, a removable, self-locking gravity pin.

PRIME-ANGLE™ Slotted Angle System

Product Introduction



Look for this icon to identify PrimeAngle applications throughout this brochure.

A complete support system that's versatile, economical, & easy to use.

- No drilling, welding or special tools necessary.
- Fast, efficient bolt-together construction.
- Easy to change and adjust.
- Cost-saving reusable materials.

With its standard 10' and 12' lengths, three strengths and two finishes, this Slotted Angle System fills a wide range of support needs and requires only a $\frac{9}{16}$ " wrench for assembly. Available in pre-galvanized and acrylic green finishes.

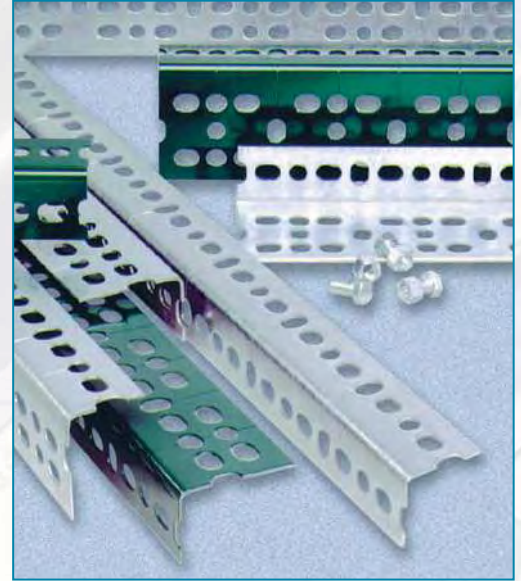

UNITED INTERLOCK® Grating System

Product Introduction



Look for this icon to identify United Interlock applications throughout this brochure.

The snap-together plank grating with a high strength-to-weight ratio... for well-built projects that come together quickly.

Strong, lightweight, economical, and versatile, United Interlock Grating Systems provide important economy and safety advantages wherever people walk. When combined with our metal framing systems, United Interlock planks are ideal for racks and other material handling applications.

The planks snap together with positive friction so welding and bolting is minimized. United Interlock planks can be easily cut to size, shape and angle at the jobsite.

United Interlock planks are available in 6", 9", and 12" widths, standard lengths of 20' and 24' with special lengths up to 30'. Two material gauges and three leg heights meet a wide range of load, space and budget requirements.

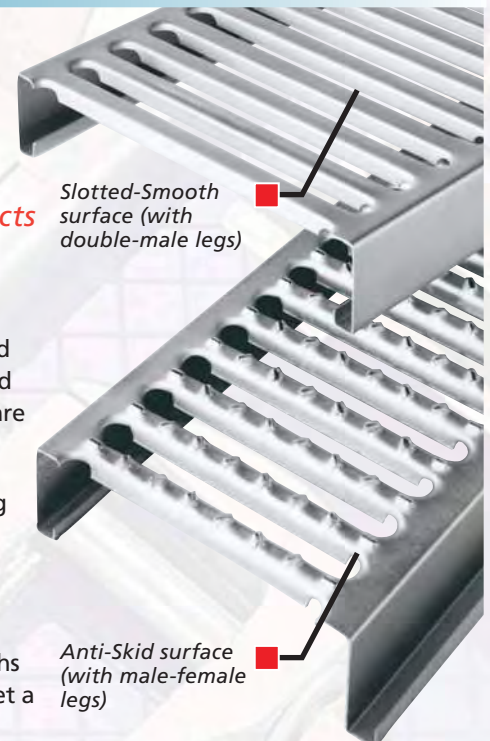

Slotted-Smooth surface (with double-male legs)

Anti-Skid surface (with male-female legs)

PRODUCT INTRODUCTIONS

UNISTRUT®

Storage Racks & Shelves

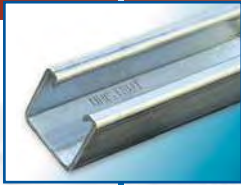

Storage racks like the one shown here are one of the earliest and most common applications for Unistrut metal framing. There are several advantages to a metal framing rack. The load capacity is determined by the channel series that is used. The shelves are fully adjustable. Just loosen the bolts that secure the fittings to the channel and you can raise or lower the shelves. Post bases can be used when the rack is placed on a concrete surface to avoid surface damage.

The simple rack is just the beginning. Our users have extended the concept in every direction, from art storage racks to complex storage systems with built in ladders.



Art Display Rack

Maximum storage and artwork display space was achieved with Unistrut Metal Framing components. The system is compact and convenient for the art client while still aesthetically pleasing.



Adjustable Cable-Dispensing Rack

This rack is expandable in three directions, a feature unique to structures made from Telestrut Telescoping Strut. It also offers sufficient load capacity for the larger cable rolls.



UNISTRUT®

Pipe & Conduit Supports

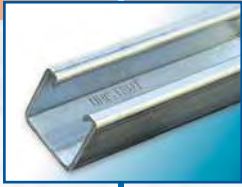

The pipe support trapeze is another classic example of Unistrut products in action. Nearly every large building requires a support structure for pipes and conduit. The wide range of channel sizes allows you to design a support that is appropriate for the loads encountered. A major advantage of Unistrut products is that you can build around structures that are already in place. Whether you are building a pipe support trapeze, a lighting support, or a rooftop stanchion, Unistrut metal framing offers a convenient solution.



Beam clamp accepts standard threaded rod.

Rollers bolt to channel, allowing effective pipe movement.

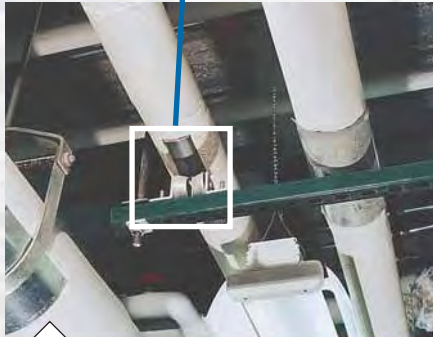

Steam Lines On Pipe Rollers

Rollers on Unistrut channel keep large pipes in place while allowing for pipe expansion and contraction as temperatures change.



Trapeze Hangers for Conduit Support

Trapeze hangers made from Unistrut channel suspended from the structural steel beams with Unistrut beam clamps provide dependable support for the conduit runs.



Lighting Support

Beam mounted channel provides support for the lighting system as well as, an electrical raceway for the fixtures.

PIPE & CONDUIT SUPPORTS

UNISTRUT®

Equipment, Tool & Sign Supports

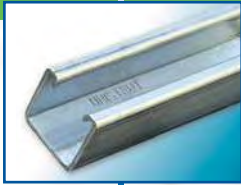

Equipment supports are often a challenge for the installer. Many items are added after construction is complete and the solution must be adapted to available space. This is where Unistrut products clearly distinguish themselves. A wide variety of channel sizes, beam clamps and fittings creates an endless variety of choices.

Inside Column Mount

Unistrut inside column mounts provide instant attachment points for small equipment like this fan.

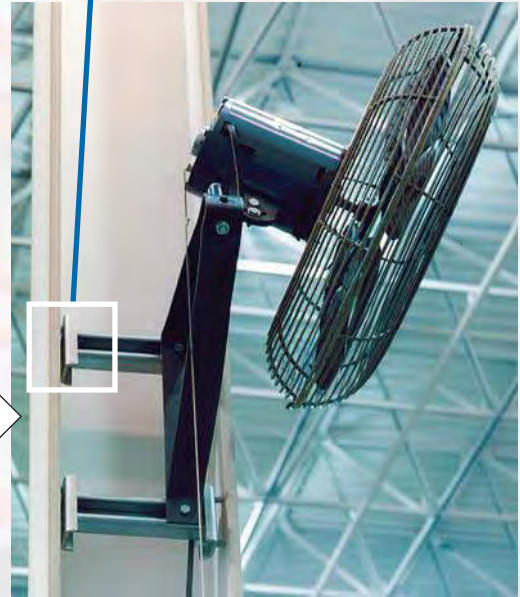

The cone-point bolts dig into the I-beam sides when tightened which provides fast, non-slip support.



Overhead Rectifier Support

Prefabricated back-to-back Unistrut sections provide plenty of beam strength for this heavy overhead rectifier.



Transformer Mounts

Extra size and weight are no problem for Unistrut Metal Framing. These equipment boxes were mounted quickly and easily without welding, drilling or special tools.



Equipment Transformer Support

Hundreds of fittings allow quick fabrication of custom supports, such as the heavy-duty brackets providing support for this transformer box.



Trolley System

Unistrut channel sections, special fittings and ball-bearing trolleys form an ideal system for suspending mobile equipment like these pneumatic carton staplers.



Cable reel is attached directly to a Unistrut trolley, which rides along in-turned channel edges.

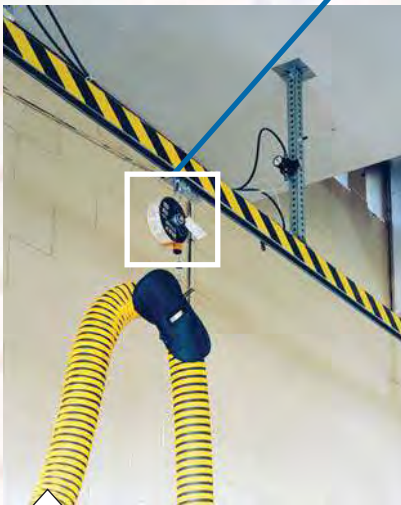

Vehicle Exhaust Release System

This trolley system made from channel attached to Telespar drops, supports flexible duct attached directly to vehicle exhaust during testing and maintenance procedures.



Panel Board Support

This panel board is framed by Unistrut sections and supported on Unistrut posts, which fit into special post bases permanently anchored in concrete.



UNISTRUT®

Ceiling Support Grids

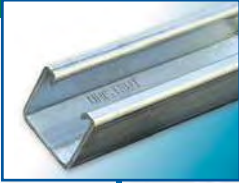

A ceiling grid can be anything from a decorative solution to a supporting structure for HVAC. The classic ceiling grid design shown here is often used for supporting ductwork, lighting and other utilities. Since the channel can be used as an electrical raceway, overhead lighting systems are often created using Unistrut metal framing.

Ceiling systems often include mezzanines and catwalks to allow easy access to the ceiling structures.

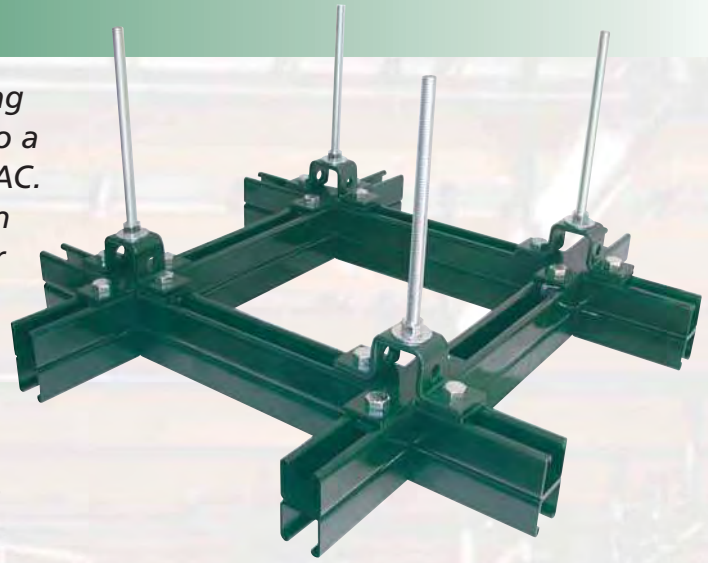

Overhead Platform Support

Channel sections with high load bearing capabilities make the Unistrut Metal Framing System ideally suited to heavy-duty applications like the supporting structure for this overhead platform.



Ceiling Grid

Drops for this grid are fabricated from threaded rod suspended from Unistrut channel, which is attached to the roof structure with Unistrut beam clamps.



Cable Tray Supports

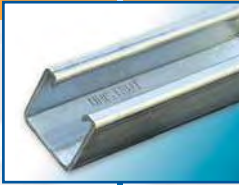

Cable tray supports are a more recent application of Unistrut products. Whether you are supporting the tray with a simple trapeze, a shelf bracket hung from a beam, or a shelf bracket attached to the wall, Unistrut channel and fittings offer a perfect solution. Cable tray systems are often forced to avoid existing structures which results in more complex support requirements. Unistrut channel offers the simple, yet flexible, method for dealing with these issues.

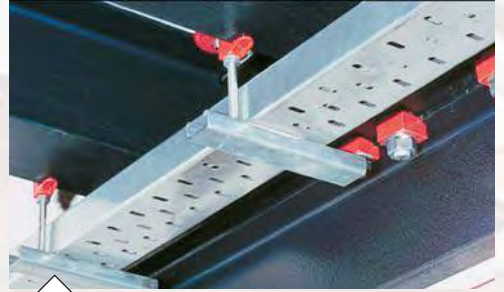

Beam-Mounted Cable Tray Supports

Cable tray is supported on a Unistrut trapeze-style hanger suspended from beam clamps.



Wall-Mounted Cable Tray Supports

Using conventional fastening methods, this Unistrut channel and bracket assembly is attached directly to a block wall.



Multi-Tier Cable Tray Supports

Because Unistrut brackets can be positioned at any point along the channel, they provide ideal supports for this multi-tier cable tray installation.



Cable Tray Brackets

Unistrut Metal Framing and brackets form an ideal cable tray support system where tight quarters require maximum support and flexibility in minimum space.



UNISTRUT®

Unipier® Rooftop Pipe Support System

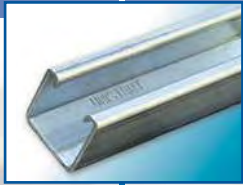

The UniPier Rooftop support system provides a simple and versatile way to support and manage pipe, tubing, conduit, HVAC systems, and the like. The UniPier system supports without roof surface penetration and allows the parts to remain off the surface.

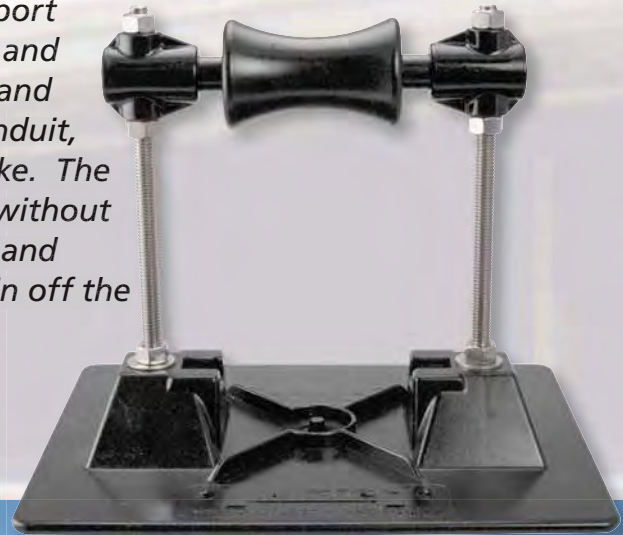

Rooftop Support

This rooftop support is a typical HVAC Unipier & channel application.



Rooftop Support

This rooftop support is a typical Unipier & channel application.

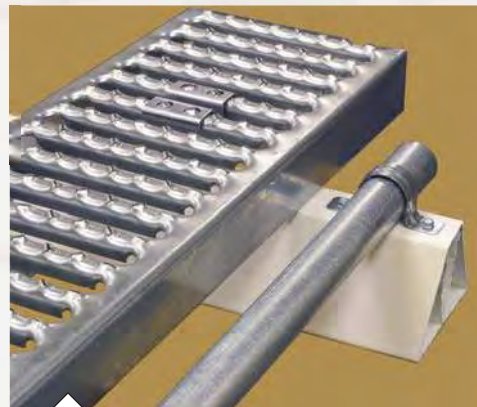

Sleeper Support

The rooftop sleeper support is a perfect support for United Interlock Grating and conduit.

UNISTRUT®

Material Handling

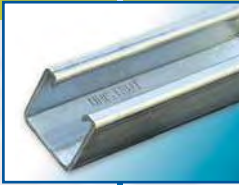

Material handling encompasses a wide variety of applications. From a simple rolling cart to complex conveyor support systems. Most factories require specialized material transfer systems, tooling supports, and specialized work areas. The flexibility of Unistrut products is an ideal choice for these structures. No welding or drilling is required and Unistrut channel can accommodate a wide variety of loading conditions.



Rolling Bar-Stock Rack

This rolling bar-stock rack features cantilevered brackets that can be quickly adjusted to accommodate changing stock requirements.



Unistrut trolleys are designed to ride on the in-turned edges of Unistrut channel, providing mobile support of up to 600 lbs. per trolley assembly.



Die-Handling Trolley System

This system makes use of back-to-back Unistrut channel track sections and ball-bearing trolleys to produce an overhead support structure with movement in two directions.



Adjustable Material Stand

A gravity conveyor is supported by a multi-purpose, adjustable material stand made from Unistrut Metal Framing and Telestrut Telescoping Strut.



Adjustments are made by loosening bolt connections and telescoping Telestrut sections to achieve desired dimension.



Conveyor Support

This conveyor support structure, made entirely from Telestrut components, is engineered to provide infinite adjustment in both width and height, making it adaptable to a wide range of conveyor styles and sizes.



MATERIAL HANDLING

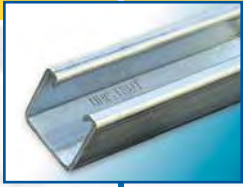

Unistrut products are a natural for creating specialized work platforms, tables, ladders and such. The Unistrut Interlock Grating is often a key element in the design. It provides a safe, slip-resistant walking surface that is free from the oil build-up that makes other surfaces slick.

Many times the factory maintenance staff must create specialized solutions according to a new demand. A small stock of Unistrut channel, grating and fittings and they have the basic components to tackle most of these requirement.



Rooftop Platform

United Interlock grating offered a convenient way to construct a walkway which avoids the existing piping structures.



Layout Table

This layout table, made from telescoping Telespar sections, can be raised or lowered, as needed.



Portable Platform

The portable platform is made entirely from United Interlock Grating. Sides are formed from un-punched sections, while the top surface is made with non-slip grating.



Machine Platform, Handrail

This platform made from United Interlock Grating, provides a safe, slip-resistant walking surface free from the oil build-up that can make ordinary surfaces slick and dangerous. Handrail is made from Unistrut channel.



UNISTRUT®

Rooftop Walkways & Supports

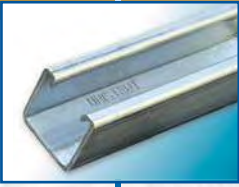

Unistrut Interlock Plank Grating System provides a functional and aesthetically appealing look to all kinds of architectural applications. The galvanized gratings resist corrosion to provide a clean look that will last. The exclusive anti-skid surface provides 360° of slip resistance and makes it ideal for harsh weather environments encountered in rooftop systems.

Unistrut channel is a great companion product in this application. Ladders, handrails, and other equipment supports can be easily constructed with Unistrut channel.

Unistrut Grating and Channel are an unbeatable team for rooftop construction projects.



Non-Slip Grating

This United Interlock mezzanine surface features an open, non-slip design that also prevents accumulation of spills and debris.



Rooftop Safety Walkway

Unistrut channel and United Interlock Grating are used to create a rooftop walkway with handrails. The roofwalk protects the roof and provides a safe walkway for pedestrians and workers especially when the weather is bad.



Rooftop Walkways

Preventing costly damage to roof surfaces is a major advantage of these Roofwalk® Rooftop Walkways, which provide safe access to rooftop equipment.



UNISTRUT®

Integrated Office & Laboratory Components

Architects have turned to Unistrut products to create specialized office and laboratory components that are functional yet aesthetically appealing. Stairs, railings, shelving, workstations can be designed to fit into the overall architecture.

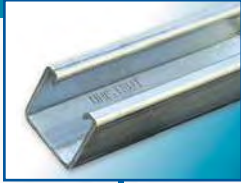

Awning Support

Unistrut channel provided the necessary load support for this special awning.

Flooring & Railings

After climbing the Telestrut created stairway, feel safe with the Interlock Grating flooring and railings made of Telestrut.



Telecom Caging

This Telecom Security Caging System designed to meet today's security requirements for the Internet server industry. This versatile system provides security for Internet server equipment while allowing trouble-free future modifications. Developed from our clean room wall system, this caging system offers the same versatility and adaptability features.

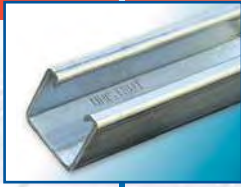

Steel Adjustable Framing Products & Accessories for Solar Installations

We offer the most complete and flexible support system available, supported by our national network of distributors and authorized service centers. Our system can handle any of your solar installation needs.



Solar Rooftop Support

This rooftop support is a typical channel, Telestrut & Unipier solar panel application.

SOLAR SUPPORT SYSTEMS

UNISTRUT®

Medical Equipment

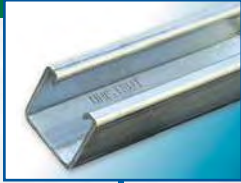

From basic X-ray machines to large integrated boom systems, to complying with seismic regulations, Unistrut can design and install the support system needed to meet your requirements. The ceiling tile flanges can be installed directly on the Unistrut Metal Framing flush with the bottom of the channel opening creating a clean, unobtrusive look consistent with today's equipment room aesthetics. Medical supports designed from Unistrut Metal framing have many advantages over conventional supporting methods including adjustability, mechanical connections, adaptability, and fast and efficient installation.



Multi-rail support system with Telespar drops.

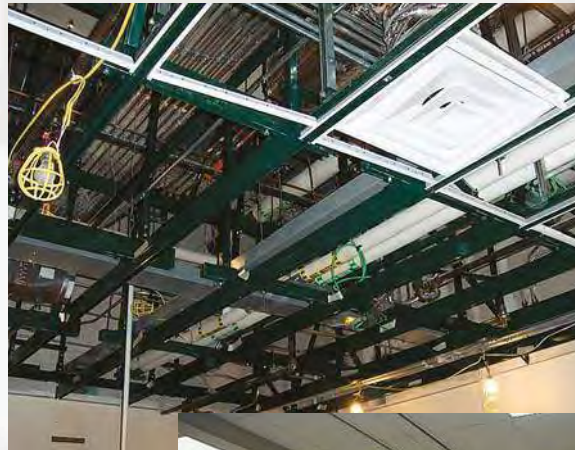

BEFORE & AFTER— Overhead Support System

The exposed interstitial grid illustrates how the equipment is supported.

The finished ceiling conceals all the support structure.



Equipment Boom & Light Support Systems

Unistrut metal framing is often used for medical support systems that meet today's demanding equipment supporting and facility requirements.



Final adjustment can be made after all components are in place, to assure precise horizontal alignment.

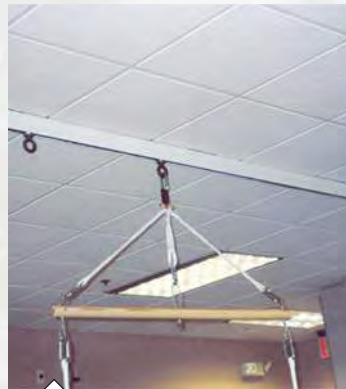

Therapy Support Systems for Children's Rehab Center

Unistrut metal framing is often used to support rehabilitation equipment.



Overhead Support System

A Unistrut trolley system designed to support heavy equipment is suspended by heavy-duty adjustable drops fabricated from Telespar tubing.



Unistrut design and installed boom support systems.



UNISTRUT® Product Pictorials

Unistrut® 1 5/8" Metal Framing

P1000 (12 ga.)

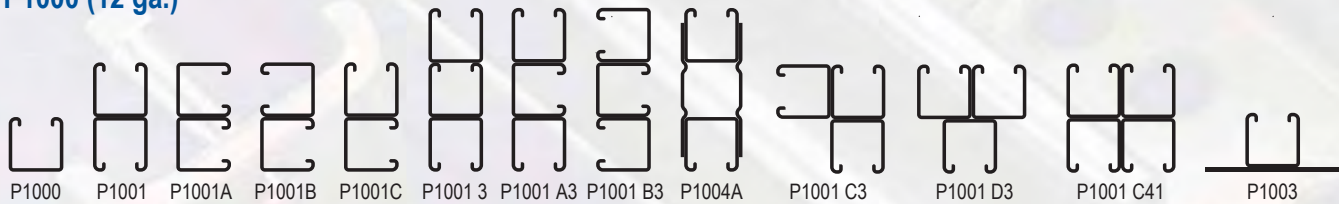

P1100 (14 ga.)

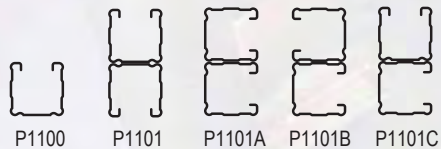

P2000 (16 ga.)

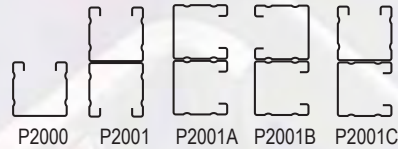

P3000 (12 ga.)

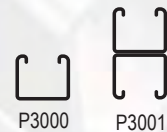

P3300 (12 ga.)

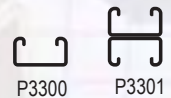

P4100 (14 ga.)

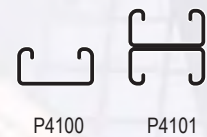

P4000 (16 gauge)

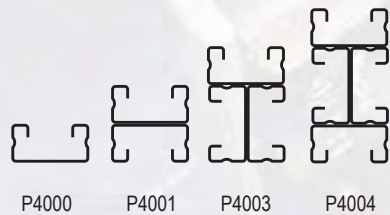

P5000 (12 ga.)



P5500 (12 ga.)



P9000 (12 ga.) Telestrut Channel

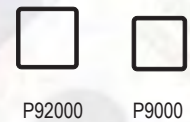

1 5/8" Channel Closure Strips

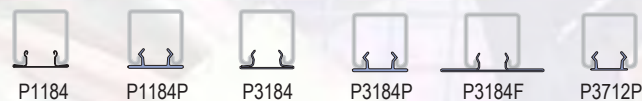

End Caps and Frame Caps



1 1/4" A - Series Alternate Metal Framing System

A1000 (14 ga.)

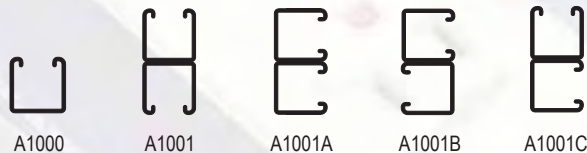

A3300 (14 ga.)

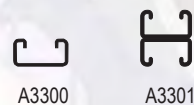

A4000 (19 ga.)

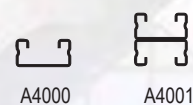

A5000 (14 ga.)



A-Series Channel Nuts & Closures



1 3/16" P6000, P7000 - Series Alternate Metal Framing Systems

P6000 (19 ga.)

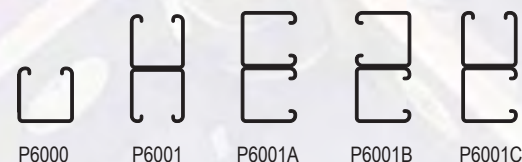

P7000 (19 ga.)

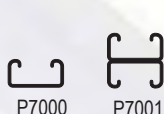

P6000, P7000 Series Channel Nuts & Closures



UNISTRUT® Product Pictorials

Unistrut® 1⁵/₈" Metal Framing

Channel Nuts

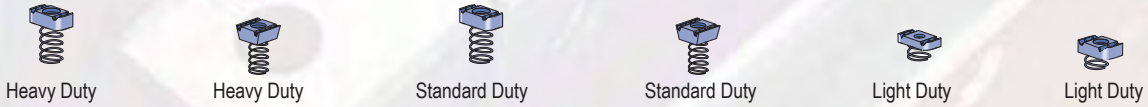

Flat Plate Fittings

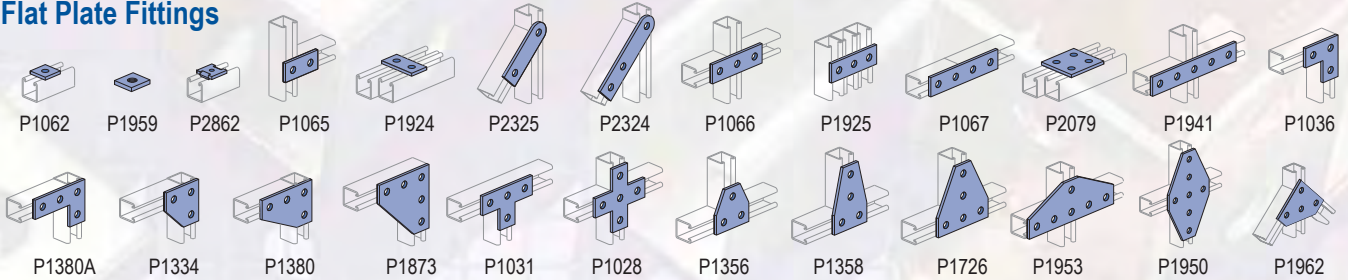

Angle Fittings

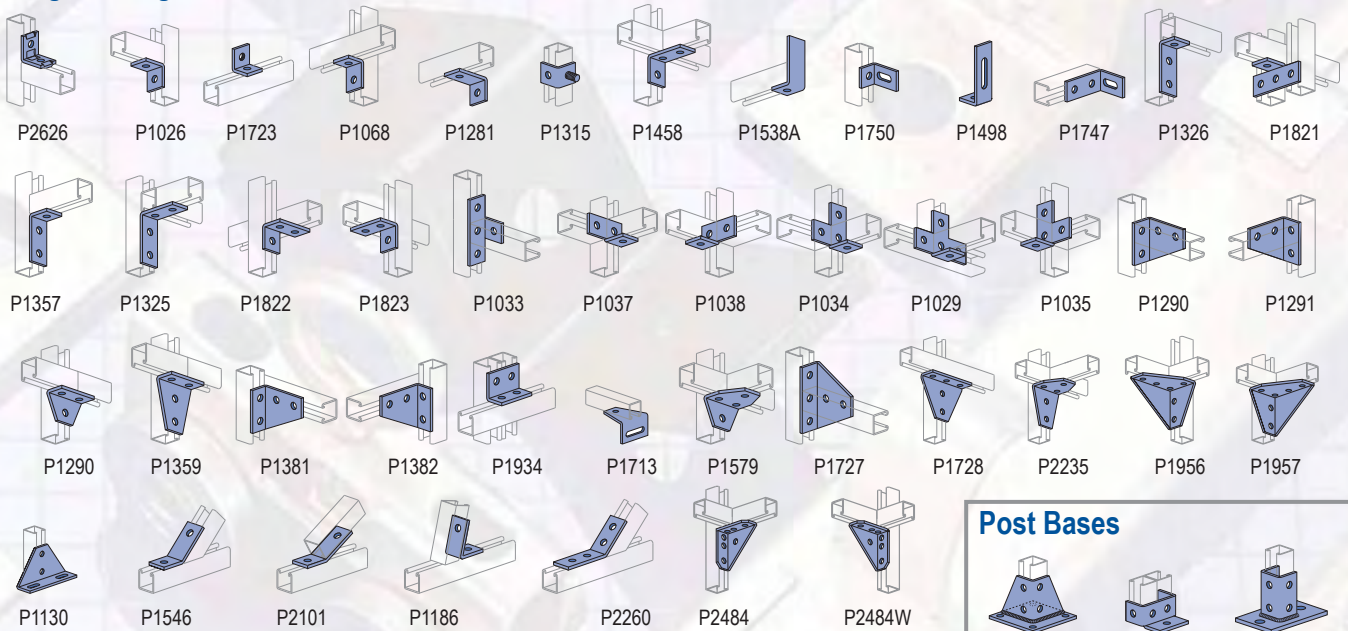

Post Bases

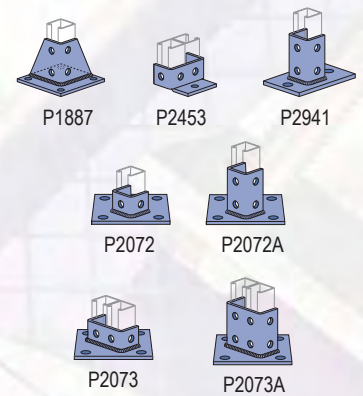

"Z" Shape Fittings

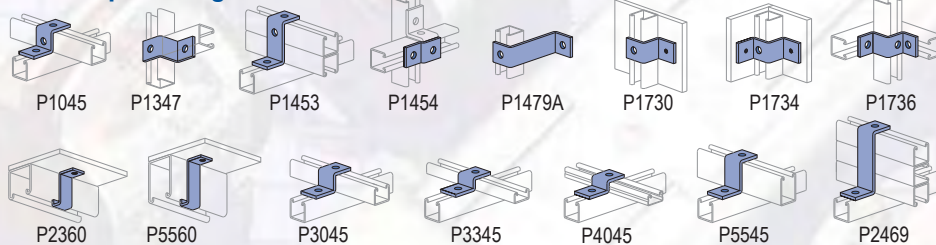

"U" Shape Fittings

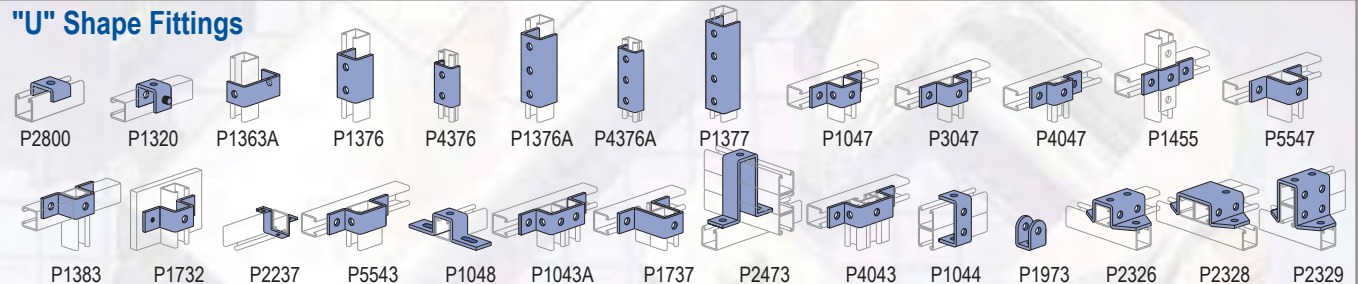

PRODUCT PICTORIALS

UNISTRUT® Product Pictorials

Unistrut® 1⁵/₈" Metal Framing

Wing Shape Fittings



Brackets & Brace Fittings

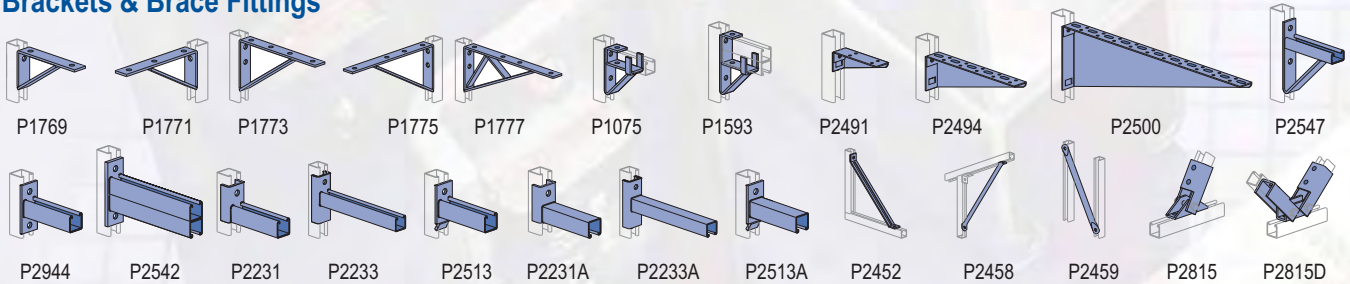

Beam Clamps

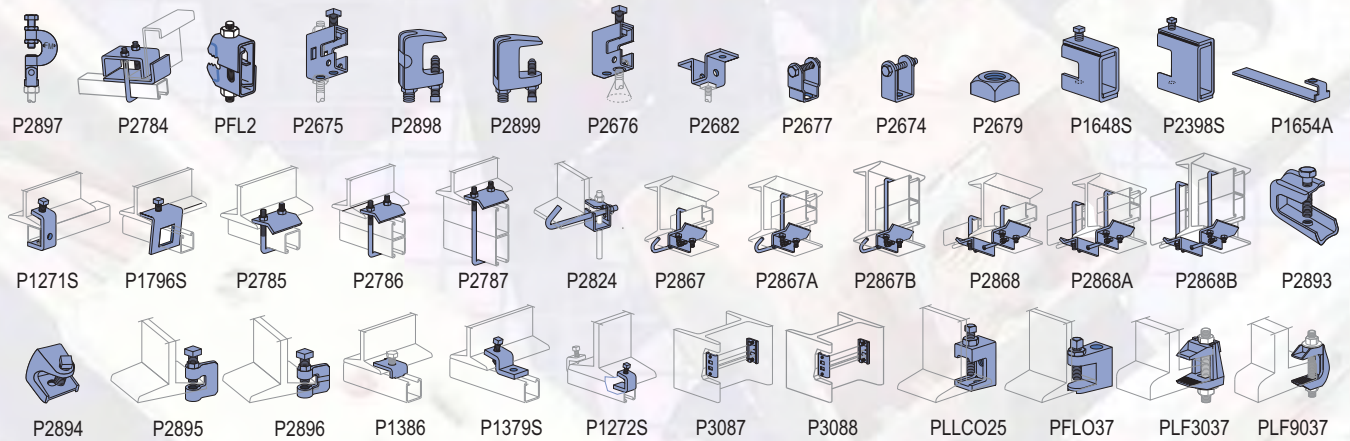

Trolley Assemblies



Seismic Retrofit Fittings

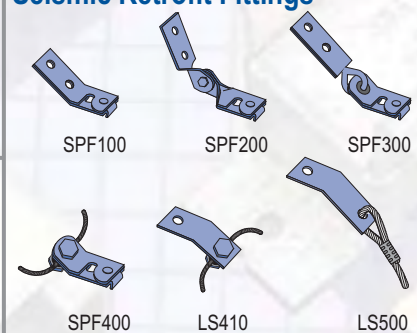

Pipe Rollers

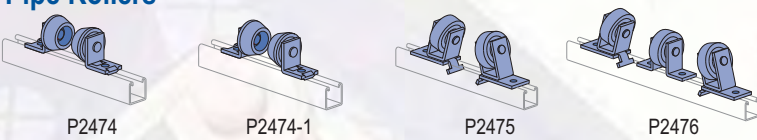

Special Applications Fittings



Product Pictorials Unistrut® 1⁵/₈" Metal Framing System

UNISTRUT® Product Pictorials

Unistrut® 1⁵/₈" Metal Framing

Pipe & Conduit Clamps, Pipe Brackets

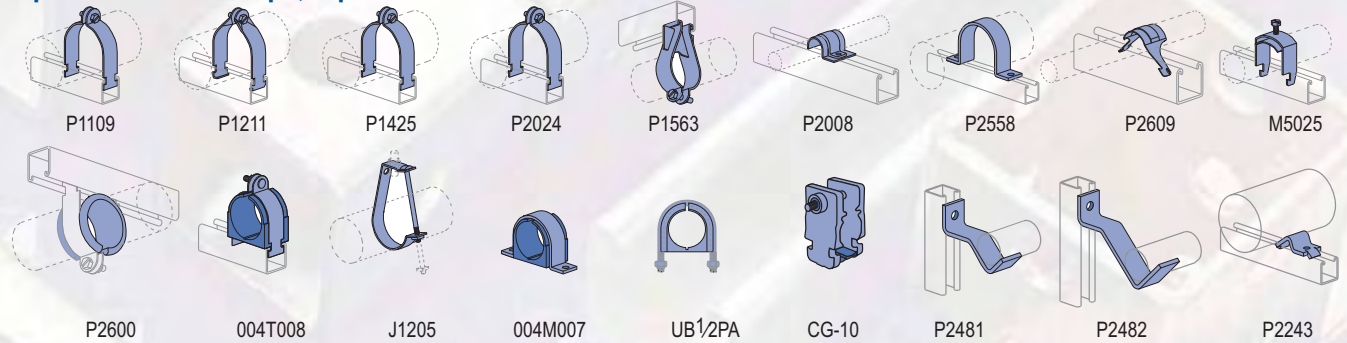

Electrical Fittings



Concrete Inserts (Heavy Duty)



Concrete Inserts (Standard Duty)

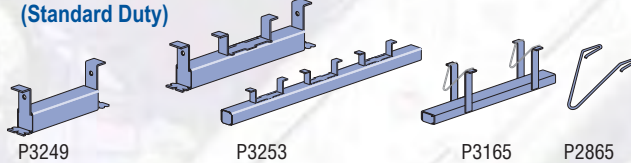

Concrete Inserts (Light Duty)

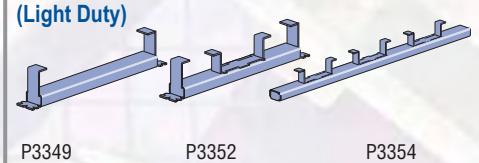

Spot Inserts & Components

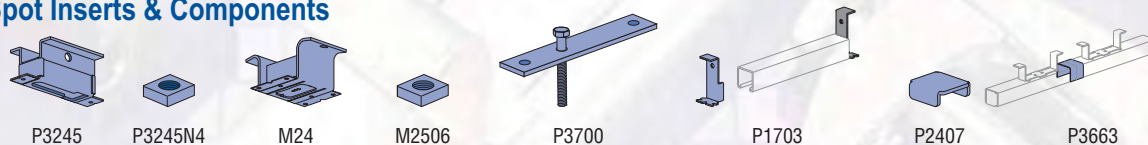

Closure Strips

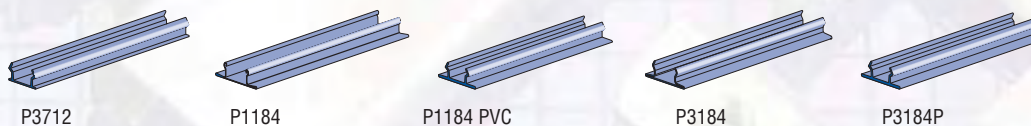

PRODUCT PICTORIALS

UNISTRUT® Product Pictorials

Unistrut® 1⁵/₈" Metal Framing

Unipier® Rooftop Pipe Support System



Sleeper Support

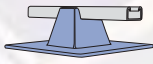

Model UP
Strut Support

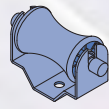

M-RBS Roller for
Model UP
Strut Support

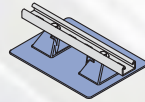

Mounted
Polycarbonate Base

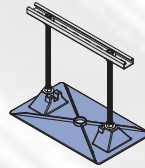

Elevated Support
Polycarbonate Base

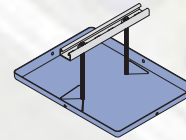

Elevated Support
Steel Base

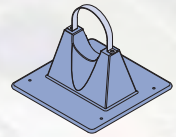

Mounted
Polycarbonate Base

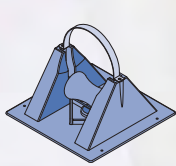

Mounted, w/Roller
Polycarbonate Base

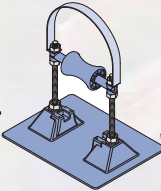

Elevated Support,
w/Roller
Polycarbonate Base

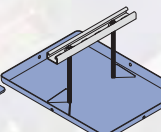

Elevated Support,
w/Roller
Steel Base

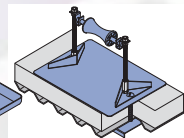

Elevated Support
[Roof Mount],
w/Roller, Steel Base

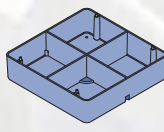

Spacer for
Model 1.5, 3-R

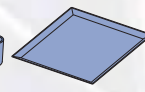

Support Pads &
Deck Plates

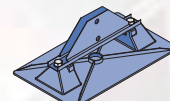

Polycarbonate
Bases

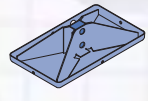

Steel Bases

Unipier® Rooftop Pipe Support System - Fabricated Supports

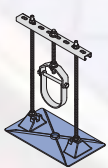

Single Base Trapeze

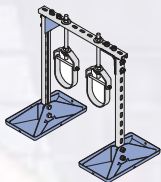

Double Base Trapeze

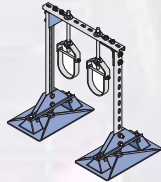

Heavy Duty,
Double Base Trapeze

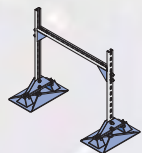

Double Base
Duct Support



Heavy Duty
Mechanical Support

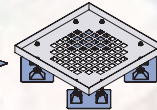

Light Duty
Mechanical Support

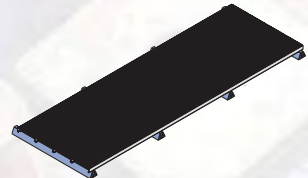

Walkways and Cross Overs

Unistrut® Telestrut Telescoping Tubing

Telestrut Tubing

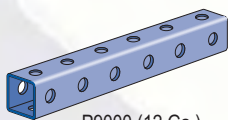

P9000 (12 Ga.)
1⁵/₈" x 1⁵/₈"

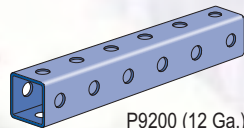

P9200 (12 Ga.)
1⁷/₈" x 1⁷/₈"

Special Fittings and Connection Hardware for Telestrut Telescoping Tubing

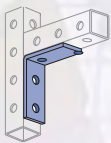

P9324

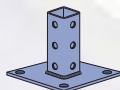

P9011

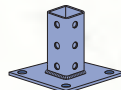

P9012

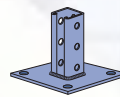

P9013

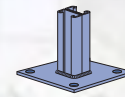

P9014



P9207



P9209



P9010

UNISTRUT® Product Pictorials

1 1/4" A - Series Alternate Metal Framing System

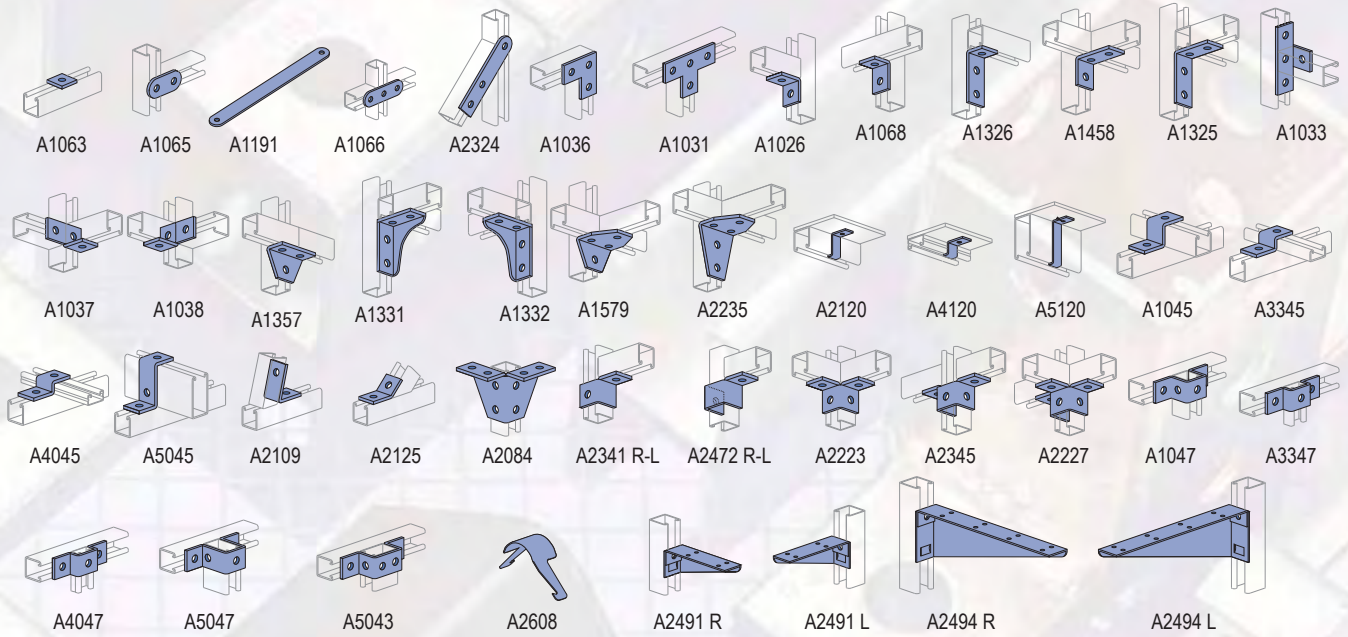

1 3/16" P6000, P7000 - Series Alternate Metal Framing Systems

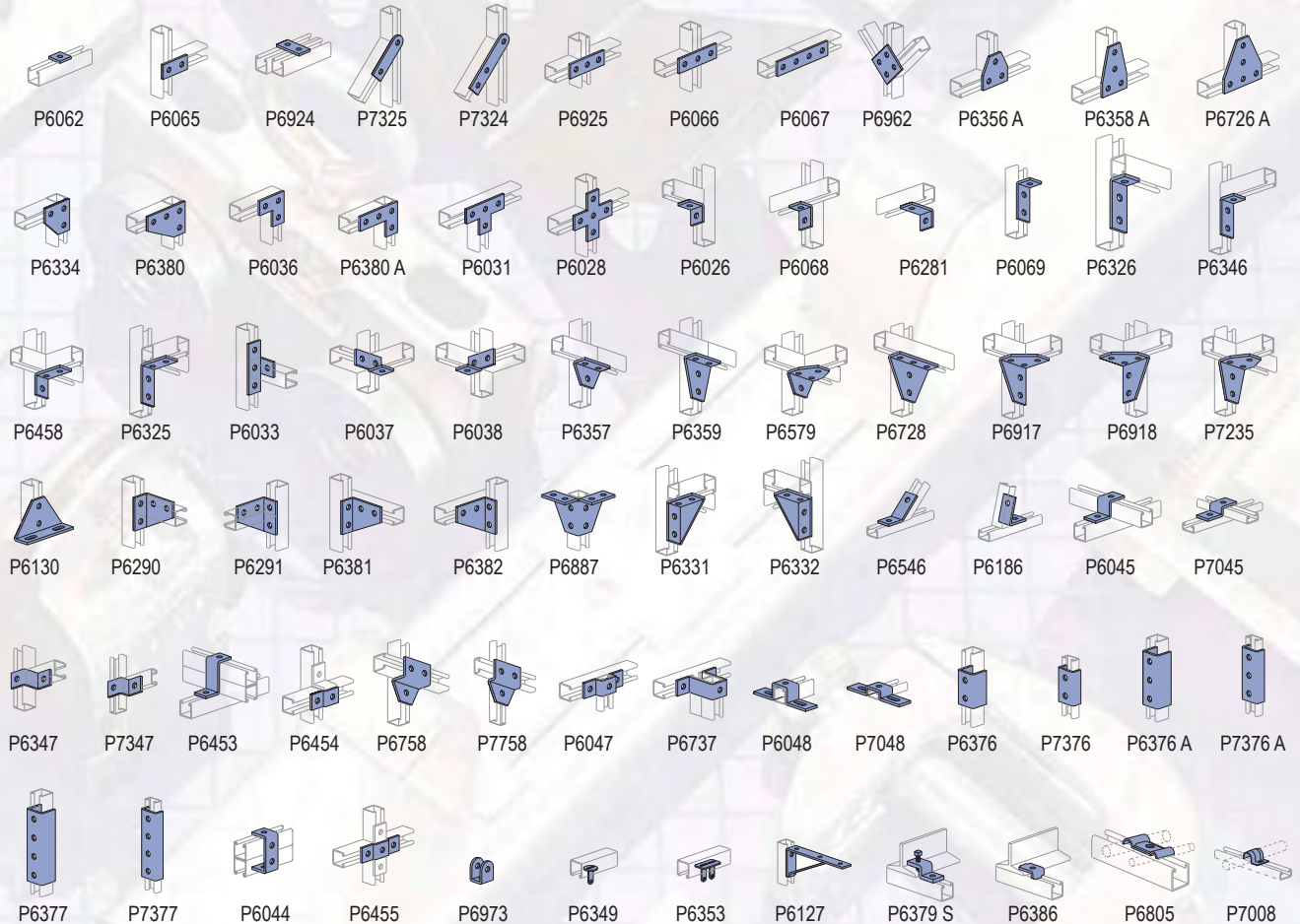

PRODUCT PICTORIALS

UNISTRUT® Product Pictorials

Unistrut® Fiberglass Framing

Heavy Duty

(Patented Flange Profile)

1½" x 1½"



F20P/V-2000

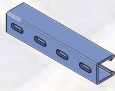

F20P/V-2200



F20P/V-2100



F20P/V-2300

Light Duty

(Patented Flange Profile)

1½" x 1"



F20P/V-1000



F20P/V-1100

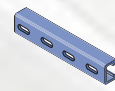

F20P/V-1200

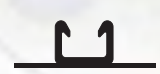

F20P/V-1300

Heavy Duty

(SST Profile)

1½" x 1½"



F20P/V-2000 SST

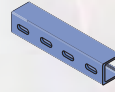

F20P/V-22000 SST



F20P/V-2100 SST



F20P/V-23000 SST

Fiberglass Concrete Inserts

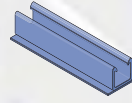

Heavy Duty

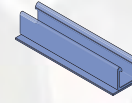

Standard Duty

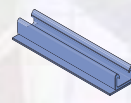

Light Duty

Hardware & Accessories



Heavy Duty



Standard Duty

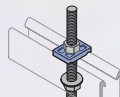

Saddle Clip

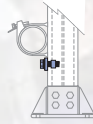

Stop Lock



Hex Flange Bolt



Hex Bolt



Hex Flange Nut



Hex Nut



Flat Washer



Spacer

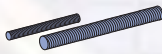

Threaded Rod

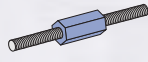

Rod Coupler



End Cap



Capping Strip



U-Bolt

Fittings

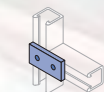

F20P/V-2500

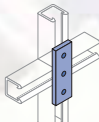

F20P/V-2502

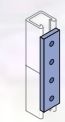

F20P/V-2504

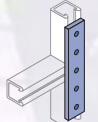

F20P/V-2506

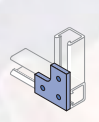

F20P/V-2508

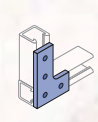

F20P/V-2510

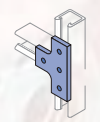

F20P/V-2512

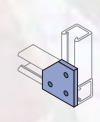

F20P/V-2514

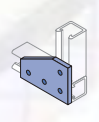

F20P/V-2516

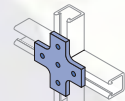

F20P/V-2518

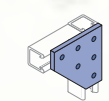

F20P/V-2520

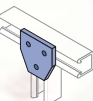

F20P/V-2522

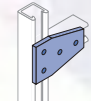

F20P/V-2524

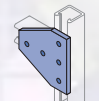

F20P/V-2526

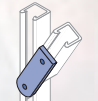

F20P/V-2528

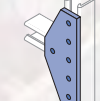

F20P/V-2530

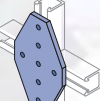

F20P/V-2534

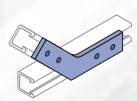

F20P/V-2540

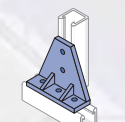

F20PU-2538

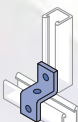

F20PU-2611

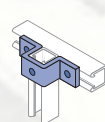

F20PU-2613

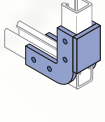

F50PU-1508
F50PU-2008

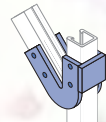

F50PU-2045

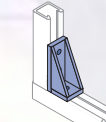

F50PU-2636

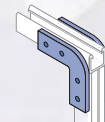

F50PU-2090

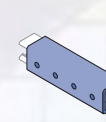

F50PU-2616

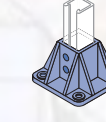

F20PU-5853
F20PU-5855

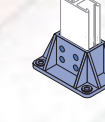

F20PU-5903
F20PU-5095

Pipe Clamps, Beam Clamps and Stanchions

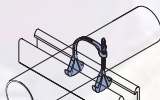

Adj. Pipe Clamp

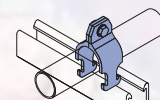

Rigid Pipe Clamp

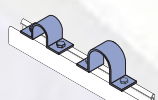

Pipe Strap

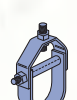

Fabricated Clevis Hanger-

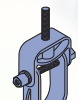

Molded Clevis Hanger

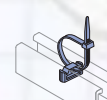

Channel Insert

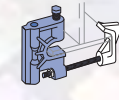

Molded Beam Clamp Assembly



Molded Beam Clamp

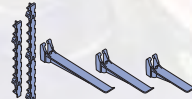

Rack Stanchion

Index

Product Introductions

Prime-Angle™ Slotted Angle System.....	5
Telespar® Telescopic Tubing	4
Telestrut® Telescopic Tubing	4
Unistrut® Metal Framing.....	3
United Interlock® Grating System.....	5

Product Pictorials

Unipier® Rooftop Support System.....	24
Unistrut® 1¼" A-Series Metal Framing System.....	25
Unistrut® 13/16" P6000, P7000 Metal Framing System.....	25
Unistrut® 1½" Metal Framing System.....	21–23
Unistrut® Fiberglass Framing System	26
Unistrut® Metal Framing Channel	20
Unistrut® Telestrut Telescoping Tubing.....	24

Application Sections

Cable Tray Supports.....	11
Ceiling Support Grids.....	10
Equipment, Tool & Sign Supports	8–9
Integrated Office & Laboratory Components	16
Material Handling.....	13
Medical Equipment.....	18–19
Pipe & Conduit Supports	7
Platforms, Tables & Risers	14
Rooftop Walkways & Supports	15
Solar Support Systems.....	17
Storage Racks & Shelves.....	6
Unipier® Rooftop Pipe Support System.....	12

Grating Products

Flooring & Railings.....	16
Machine Platform, Handrail	14
Non-Slip Rooftop Walkway.....	15
Overhead Platform Support	10
Portable Platform	14
Rooftop Platform.....	14
Rooftop Safety Walkway	15
Rooftop Walkways.....	15
Sleeper Support	12

Metal Framing Products

Adjustable Cable-Dispensing Rack.....	6
Adjustable Material Stand.....	13
Art Display Rack.....	6
Awning Support	16
Beam-Mounted Cable Tray Supports.....	11
Cable Tray Brackets.....	11
Ceiling Grid.....	10

Die-Handling Trolley System.....	13
Equipment Boom & Light Support Systems	19
Equipment Transformer Support.....	9
Flooring & Railings.....	16
Inside Column Mount.....	8
Lighting Support	7
Machine Platform, Handrail.....	14
Medical Boom Support Systems.....	19
Multi-Rail Medical support system.....	18
Multi-Tier Cable Tray Supports	11
Overhead Platform Support	10
Overhead Rectifier Support.....	8
Overhead Support System	19
Panel Board Support	9
Pipe & Conduit Supports	7
Rooftop Safety Walkway	15
Rooftop Support.....	12
Solar Support Systems.....	17
Steam Lines On Pipe Rollers	7
Storage Rack	6
Telecom Caging	16
Therapy Support Systems for Children's Rehab Center	19
Transformer Mounts.....	8
Trapeze Hangers for Conduit Support.....	7
Trolley System	9
Vehicle Exhaust Release System.....	9
Wall-Mounted Cable Tray Supports.....	11

Telespar Products

Layout Table.....	14
Medical Boom Support Systems.....	19
Multi-Rail Medical Support System.....	18
Overhead Support System	19
Rolling Bar-Stock Rack.....	13
Vehicle Exhaust Release System.....	9

Telestrut Products

Adjustable Cable-Dispensing Rack.....	6
Adjustable Material Stand.....	13
Conveyor Support	13
Solar Support Systems.....	17

Unipier Products

Rooftop Support.....	12
Sleeper Support	12
Solar Support Systems.....	17

16100 South Lathrop Avenue
Harvey, IL 60426
TOLL-FREE / 800-882-5543
FAX / 708-339-7814
www.unistrut.com

585 Finley Avenue
Ajax, Ontario, L1S 2E4 Canada
PHONE / 905-683-8131
FAX / 905-683-8987



UNISTRUT®

Columbia-MBF™

UNISTRUT®
Construction

KAF-TECH®



COPE®



GEM
FABRICATION



RAZOR®
RIBBON

