



ATKORE DEFENDER™

Corrosion Resistant Metal Framing Line



Atkore[™]
Unistrut

Corrosion Protection



Atkore Defender™

Atkore Defender is designed for harsh environments, providing a service life between Hot-Dip Galvanized and stainless steel systems. Independent testing shows that Atkore Defender is **THREE** times more corrosion-resistant than Hot-Dip Galvanized products. In addition, Atkore Defender avoids the use of costly stainless steel hardware. Atkore Defender is a great choice for harsh and corrosive environments.

Get better performance with Atkore Defender. This brochure lists the Unistrut Defender parts, dimensions and applications that are commonly in stock. Many other Unistrut parts can be made by request. For more information about Atkore Defender, contact your Atkore Regional Sales Manager, Agent or call 800-882-5543.



The Atkore Defender coating was tested against the traditional Hot-Dip Galvanized coating by an independent, accredited 3rd party laboratory for 3,000 hours of continuous salt spray exposure per ASTM B117. The test was conclusive, proving that

Atkore Defender outperforms Hot-Dip Galvanizing by lasting 3 times as long before reaching the 5% red rust failure criteria! **The photos below show the clearly superior performance provided by Atkore Defender.**

PHOTOS FROM ASTM B117 SALT SPRAY TEST

	0 hours	100 hours	1,000 hours	2,000 hours	3,000 hours
Atkore Defender™ (DF)					
Hot-Dip Galvanized (HG) per ASTM A123 and A153					

With over 3 times the corrosion protection of Hot-Dip Galvanized products, the anticipated service life for Atkore Defender vastly outperforms traditional carbon steel framing systems.

Atkore Defender will meet the design life of most new applications, eliminating the need to replace parts over time. See the difference below!

ANTICIPATED SERVICE LIFE (Time to 5% Red Rusting of the Steel Surface)

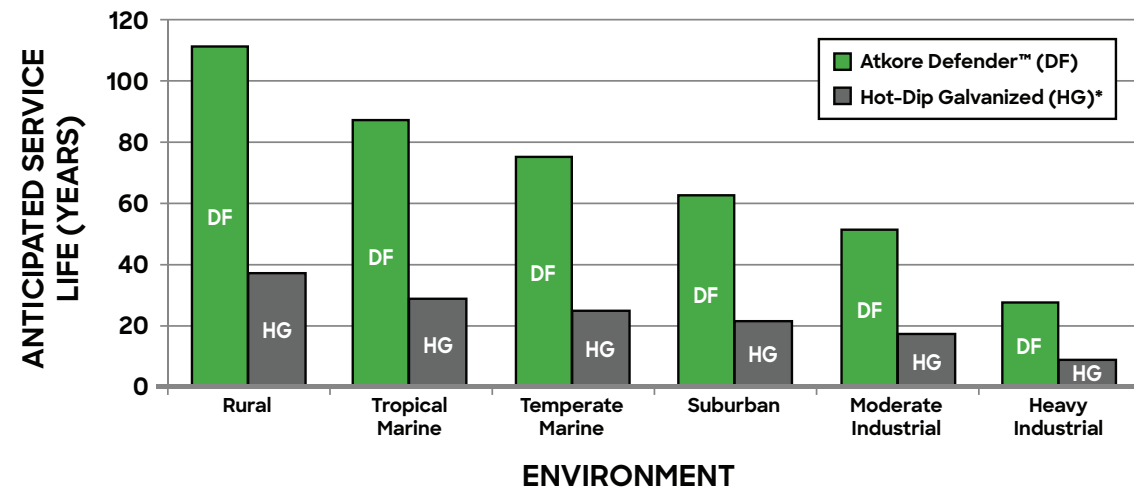

*Hot-Dip Galvanized per ASTM A123 and A153 coating service life as specific within the North American Metal Framing Industry

TYPICAL APPLICATION DESIGN LIFE¹ VS. ANTICIPATED SERVICE LIFE

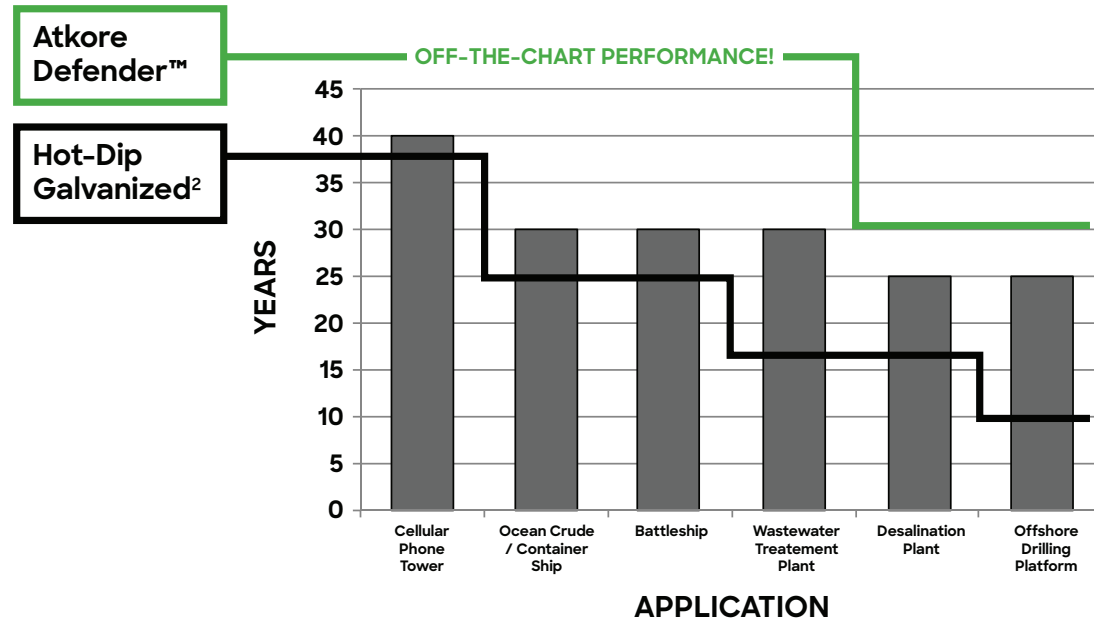

¹) Typical application design life is sourced from a number of different publications and is not true for all applications. Reference your project-specific requirements and environment for a true performance estimate.

²) Hot-Dip Galvanized per ASTM A123 and A153 coating service life as specific within the North American Metal Framing Industry

Finishes:

Atkore Defender is a combination of two proprietary material coatings conforming to ASTM standards A1046 and A1059.

Materials:

Channel, Fittings and Pipe Clamps meet the physical requirements of ASTM A1011 SS GR 33.

Technical Notes:

1. Structural performance, including Slip and Pull-Out Loads, meets all Allowable Loads as specified in the Unistrut General Engineering catalog for carbon steels. Please reference the Unistrut General Engineering catalog for this information.
2. To achieve full performance and cost benefits, Atkore Defender must be used as a complete metal framing system. In addition, caution should be taken when putting Atkore Defender in contact with stainless steel materials due to a dissimilar metals condition that may cause galvanic corrosion.
3. Some red staining may be observed over time on Atkore Defender parts in corrosive environments. Red staining is superficial oxidation of the zinc/iron ions at the surface, and not corrosion of the substrate steel. This is noted in ASTM A1059 section 6.3.
4. One of the unique characteristics of Atkore Defender strut channel is that it contains self-healing properties. If the product is cut or scratched in the field, the finish will propagate into those areas eliminating the need for secondary touch-ups.



1 5/8" Channel

P1000 DF (12 Gauge).....	6
P3300 DF (12 Gauge).....	7
P4100 DF (14 Gauge).....	8
P5000 DF (12 Gauge).....	9

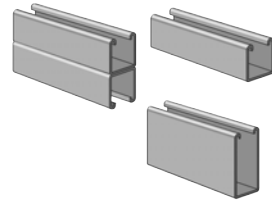

Standard Lengths

Standard lengths are 10 feet (3.05m) and 20 feet (6.10m). Tolerances are ±1/8" (3 mm). Special lengths are available for a small cutting charge with a tolerance of ±1/8" (3 mm).

Dimensions

Imperial dimensions are illustrated in inches. Metric dimensions are shown in millimeters and rounded to one decimal place.

Nuts & Hardware

Channel Nuts With Springs	10
Channel Nuts Without Springs	10
Hardware	10

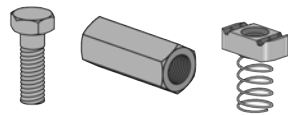

Threads

All threads on the nuts and bolts are Unified and American coarse screw threads.

Dimensions

Imperial dimensions are illustrated in inches. Metric dimensions are shown in parentheses or as noted. Unless noted, all metric dimensions are in millimeters and rounded to one decimal place.

General Fittings & Beam Clamps

General Fittings.....	12
Beam Clamps.....	15

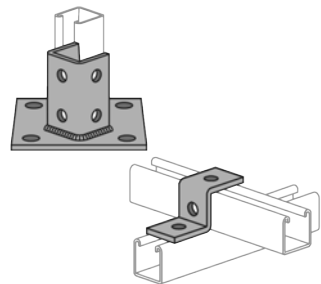

Application

All parts drawings illustrate only one application of each fitting. In most cases many other applications are possible. The channels shown in the illustrations are P1000, 1 5/8" square, except where noted otherwise.

All 9/16" diameter holes use 1/2" x 1 3/16" hex head cap screws and 1/2" nuts - P1010, P4010 or P5510 - depending on the channel used.

Beam Clamps

Clamps are designed to be used with W, M, S and HP Shape beams, Standard C and Miscellaneous MC Channels, Angles and Structural Tees. Clamps must be used in pairs where indicated.

Pipe/Conduit Supports

Pipe/Conduit Clamps	16
---------------------------	----

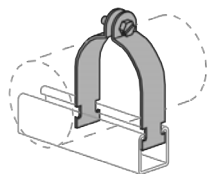

Application

Unistrut pipe clamps are designed for the support of electrical and mechanical services. Supports to meet nearly every requirement can be attained using Unistrut Metal Framing components.

Dimensions

Imperial dimensions are illustrated in inches. Metric dimensions are shown in parenthesis or as noted. Unless noted, all metric dimensions are in millimeters and rounded to one decimal place.

1 5/8" Channel

P1000® DF & P1001 DF Channels

P1000 DF

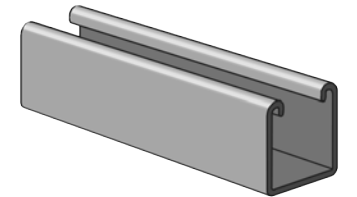
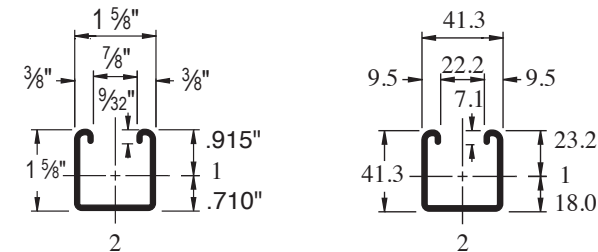

Wt/100 ft: 189 lbs (281 kg/100 m)
Allowable Moment 5,070 in-lbs (570 N·m)
12 Gauge Nominal Thickness .105" (2.7mm)

P1001 DF

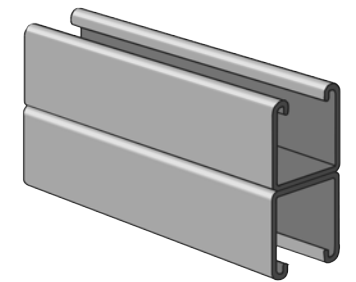
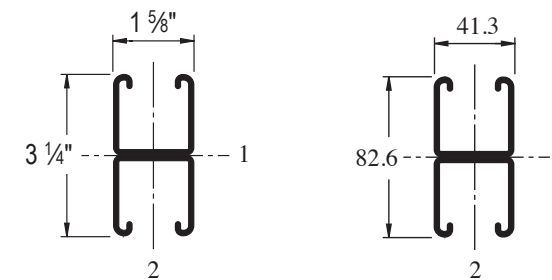

Wt/100 ft: 378 lbs (562 kg/100 m)
Allowable Moment 14,360 in-lbs (1,620 N·m)
12 Gauge Nominal Thickness .105" (2.7mm)

P1000T DF

Slots are
1 1/8" (28.6) x 9/16" (14.3)
2" (50.8) on Center

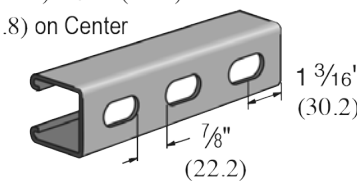

Wt/100 ft: 185 lbs (275 kg/100 m)

P1001T DF

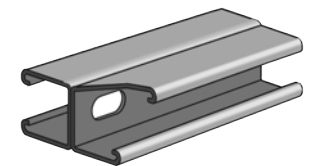

Wt/100 ft: 321 lbs (478 kg/100 m)
Allowable Moment 12,200 in-lbs (1,378 N·m)
12 Gauge Nominal Thickness .105" (2.7mm)

Channel Nuts (Refer to Hardware Section for Details)

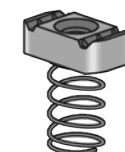

P1006-1420 DF
P1008 DF
P1010 DF



P3006-1420 DF
P3008 DF
P3010 DF

Standard Channel Lengths: 10' & 20'



P3300® DF & P3301 DF Channels

P3300 DF

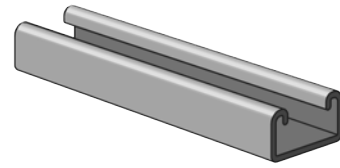
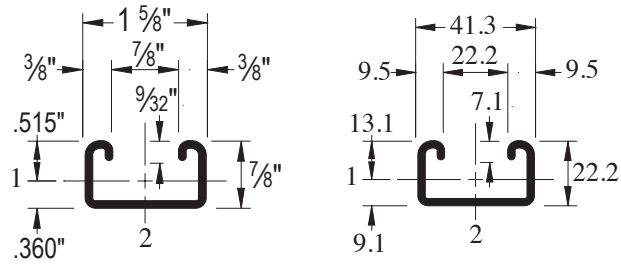

Wt/100 ft: 134 lbs (200 kg/100 m)
Allowable Moment 1,800 in-lbs (200 N·m)
12 Gauge Nominal Thickness .105" (2.7mm)

P3301 DF

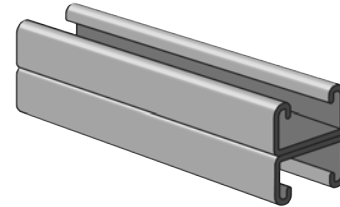
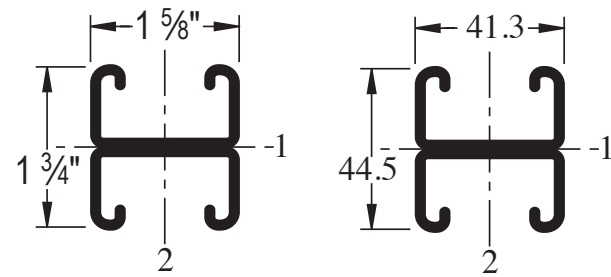

Wt/100 ft: 269 lbs (400 kg/100 m)
Allowable Moment 5,060 in-lbs (570 N·m)
12 Gauge Nominal Thickness .105" (2.7mm)

P3300T DF

Slots are
1 1/8" (28.6) x 9/16" (14.3)
2" (50.8) on Center

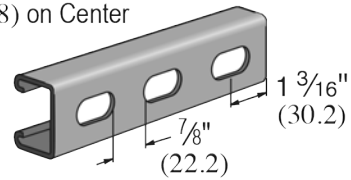

Wt/100 ft: 130 lbs (193 kg/100 m)

P3301T DF

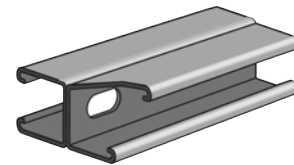

Wt/100 ft: 260 lbs (386 kg/100 m)

Channel Nuts (Refer to Hardware Section for Details)



P4006-1420 DF
P4008 DF
P4010 DF



P3006-1420 DF
P3008 DF
P3013 DF

Standard Channel Lengths: 10' & 20'

P4100® DF & P4101 DF Channels

P4100 DF

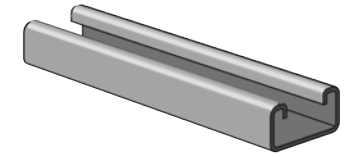
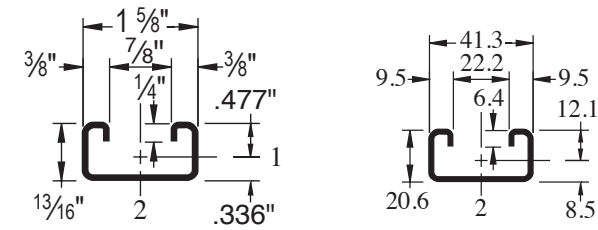

Wt/100 ft: 98 lbs (147 kg/100 m)
Allowable Moment 1,360 in-lbs (150 N·m)
14 Gauge Nominal Thickness .075" (1.9mm)

P4101 DF

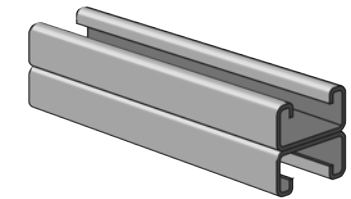
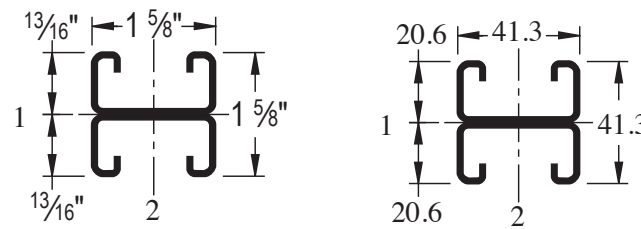

Wt/100 ft: 197 lbs (293 kg/100 m)
Allowable Moment 3,610 in-lbs (410 N·m)
14 Gauge Nominal Thickness .075" (1.9mm)

P4100T DF

Slots are
1 1/8" (28.6) x 9/16" (14.3)
2" (50.8) on Center

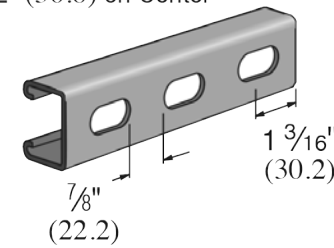

Wt/100 ft: 87 lbs (129 kg/100 m)

P4101T DF

Slots are
1 1/8" (28.6) x 9/16" (14.3)
2" (50.8) on Center

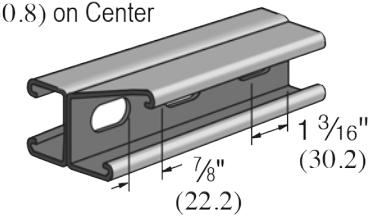

Wt/100 ft: 174 lbs (259 kg/100 m)

Channel Nuts (Refer to Hardware Section for Details)



P4006-1420 DF
P4008 DF
P4010 DF

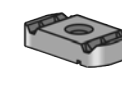

P3006-1420 DF
P3008 DF
P3013 DF

Standard Channel Lengths: 10' & 20'



P5000® DF & P5001 DF Channels

P5000 DF

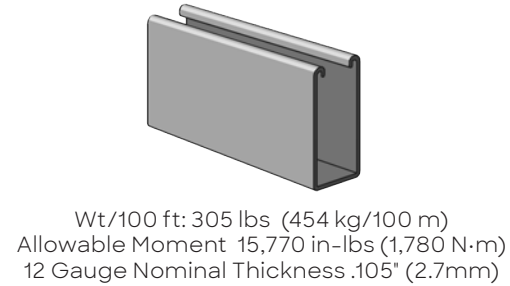
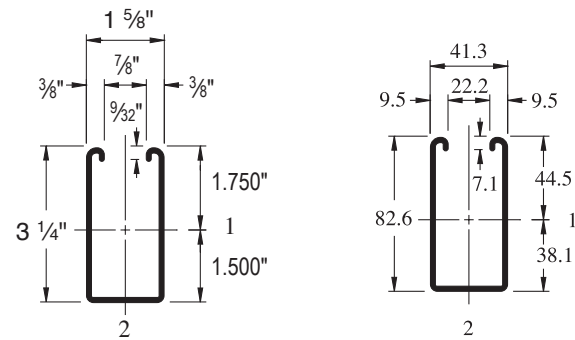

P5001 DF

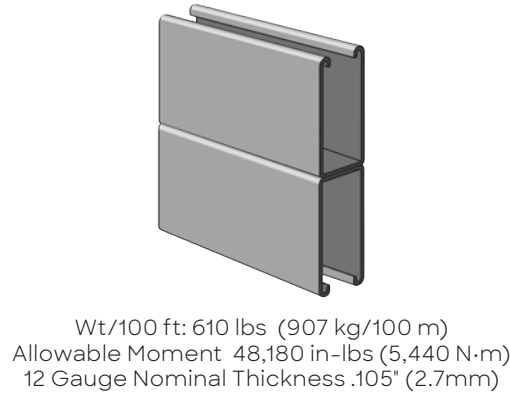
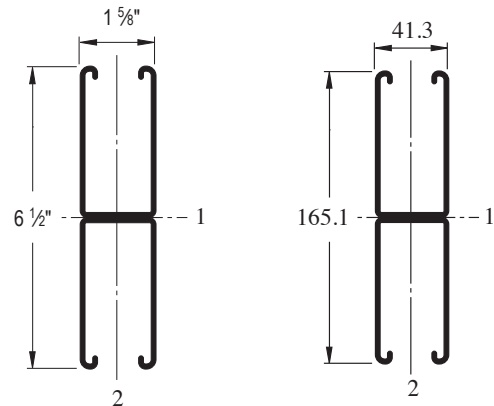

P5000T DF

Slots are
1 1/8" (28.6) x 9/16" (14.3)
2" (50.8) on Center

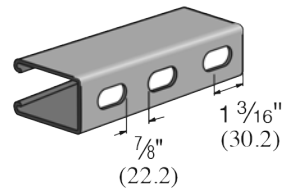

Wt/100 ft: 300 lbs (446 kg/100 m)

P5001T DF

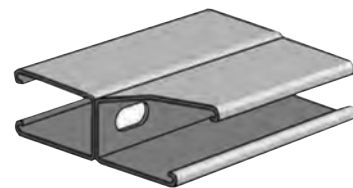

Channel Nuts (Refer to Hardware Section for Details)

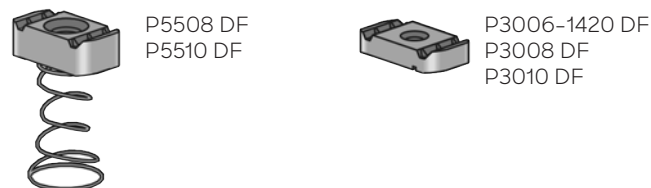

Standard Channel Lengths: 10' & 20'

Channel Nuts With and Without Spring

Channel Nut With Spring

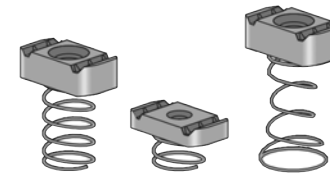

Part Number	Nut Size	Thread	Wt/100 pcs lbs (kg)	Use With
P1006-1420 DF	1/4"	-20	7 (3.2)	P1000 DF
P1008 DF	3/8"	-16	10 (4.5)	
P1010 DF	1/2"	-13	12 (5.4)	
P4008 DF	3/8"	-16	9 (4.1)	P3300 DF, P4100 DF
P4010 DF	1/2"	-13	8 (3.6)	
P5508 DF	3/8"	-16	10 (4.5)	P5000 DF
P5510 DF	1/2"	-13	12 (5.4)	

Channel Nut Without Spring

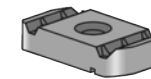

Part Number	Nut Size	Thread	Wt/100 pcs lbs (kg)	Use With
P3006-1420 DF	1/4"	-20	6 (2.7)	Any Channel
P3008 DF	3/8"	-16	9 (4.1)	
P3010 DF	1/2"	-13	11 (5.0)	P1000 DF, P4100 DF
P3013 DF	1/2"	-13	8 (3.6)	P3300 DF, P4100 DF

Hardware

HEX Head Cap Screws

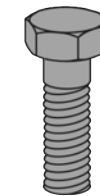

Part Number	Size	Wt/100 pcs lbs (kg)
HHCS025075DF	1/4" x 3/4"	1.3 (0.6)
HHCS025150DF	1/4" x 1 1/2"	2.6 (1.2)
HHCS037100DF	3/8" x 1"	4.5 (2.0)
HHCS037150DF	3/8" x 1 1/2"	6.0 (2.7)
HHCS050094DF	1/2" x 1 5/16"	9.1 (4.1)
HHCS050119DF	1/2" x 1 3/8"	10.2 (4.6)
HHCS050150DF	1/2" x 1 1/2"	11.6 (5.3)

Hexagon Nuts



Part Number	Size	Wt/100 pcs lbs (kg)
HHXN025DF	1/4"	0.6 (0.3)
HHXN037DF	3/8"	1.6 (0.7)
HHXN050DF	1/2"	4.8 (2.2)

Flat Washers



Part Number	Size	Wt/100 pcs lbs (kg)
HFLW025DF	1/4"	0.8 (0.4)
HFLW037DF	3/8"	1.5 (0.7)
HFLW050DF	1/2"	3.5 (1.6)



Hardware

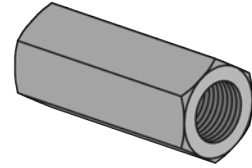

Steel Coupler Nuts

Part Number	Size	Length (mm)	Wt/100 pcs lbs (kg)
HRCN037DF	3/8" - 16	1 3/4" (44.5)	9.0 (4.1)
HRCN050DF	1/2" - 13	1 3/4" (44.5)	10.0 (4.5)

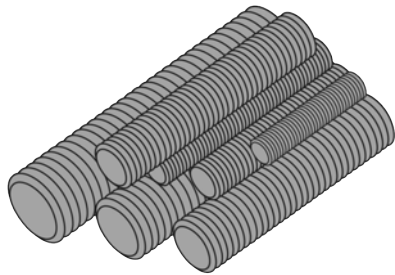

Steel Threaded Rod

Part Number	Size	Wt/100 pcs lbs (kg)
HTHR037DF	3/8" - 16	30 (13.6)
HTHR050DF	1/2" - 13	53 (24.0)

Low Carbon Steel Grade 1006 - 1010
 Fy = 36,000 psi minimum
 Ft = 58,000 psi minimum

Standard Length 6' (1.83m)

Lock Washers



Part Number	Size	Wt/100 pcs lbs (kg)
HLKW025DF	1/4"	0.25 (0.1)
HLKW037DF	3/8"	0.63 (0.3)
HLKW050DF	1/2"	1.32 (0.60)

General Fittings

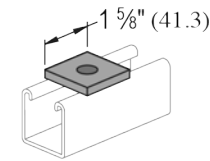

P1063 DF, P1064 DF

Part Number	Bolt Size	Hole Size	Wt/100 pcs lbs (kg)
P1063 DF	3/8"	7/16"	18 (8.2)
P1064 DF	1/2"	9/16"	17 (7.7)

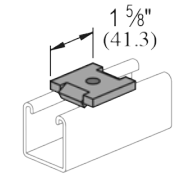

P2863 DF, P2864 DF

Part Number	Bolt Size	Hole Size	Wt/100 pcs lbs (kg)
P2863 DF	3/8"	7/16"	18 (8.2)
P2864 DF	1/2"	9/16"	17 (7.7)

P1065 DF

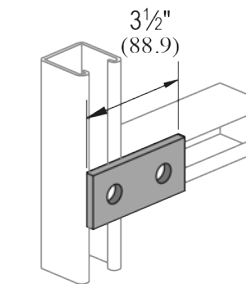

Wt/100 pcs: 38 lbs (17.2 kg)

P2324 DF

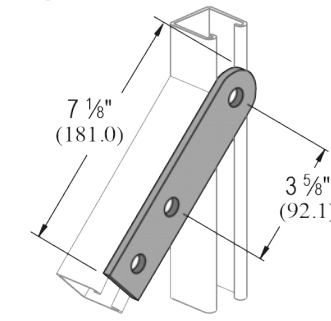

Wt/100 pcs: 75 lbs (34.0 kg)

P1066 DF

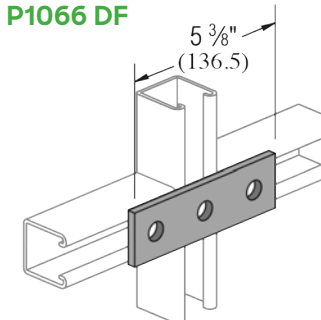

Wt/100 pcs: 56 lbs (25.4 kg)

P1067 DF

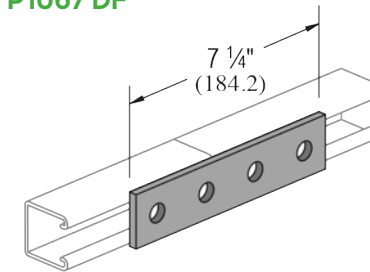

Wt/100 pcs: 78 lbs (35.4 kg)

P1036 DF

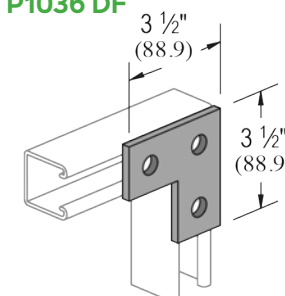

Wt/100 pcs: 58 lbs (26.3 kg)

P1380A DF

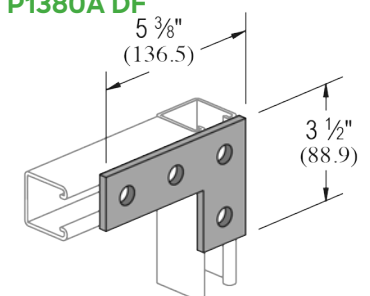

Wt/100 pcs: 105 lbs (47.6 kg)

Standard Dimensions for 15/8" (41.3mm) width series channel fittings (Unless Otherwise Shown on Drawing)
 Hole Diameter: 9/16" (14.3mm); Hole Spacing - From End: 13/16" (20.6mm); Hole Spacing - On Center: 17/8" (47.6mm); Width: 15/8" (41.3mm); Thickness: 1/4" (6.4mm)



General Fittings

P1031 DF

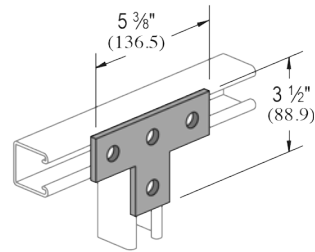

Wt/100 pcs: 80 lbs (36.3 kg)

P1028 DF

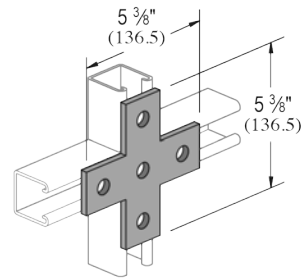

Wt/100 pcs: 105 lbs (47.6 kg)

P1026 DF

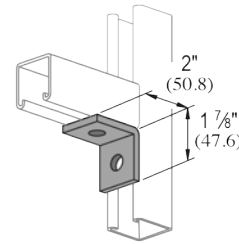

Wt/100 pcs: 38 lbs (17.2 kg)

P1068 DF

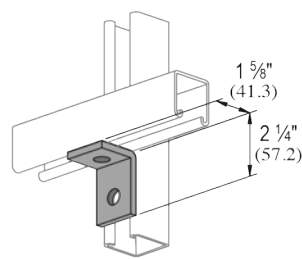

Wt/100 pcs: 38 lbs (17.2 kg)

P1346 DF

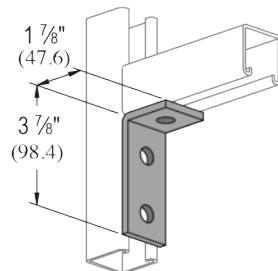

Wt/100 pcs: 58 lbs (26.3 kg)

P1325 DF

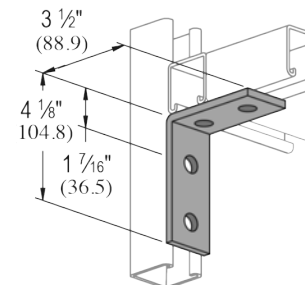

Wt/100 pcs: 78 lbs (35.4 kg)

P2484 DF

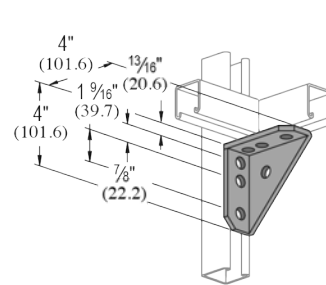

Wt/100 pcs: 134 lbs (60.8 kg)

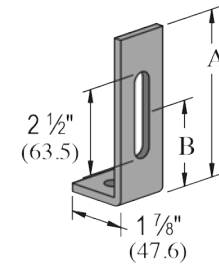

P1498 DF

Part Number	"A" in (mm)	"B" in (mm)	Wt/100 pcs lbs (kg)
P1498 DF	4 7/8"	2 1/2"	65 (29.5)

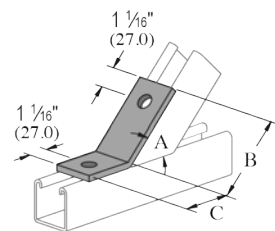

P1546 DF

Part Number	"A" in (mm)	"B" in (mm)	"C" in (mm)
P1546 DF	45° (0.79)	3 (76.2)	2 5/16 (58.7)

Wt/100 pcs: 58 lbs (26.3 kg)

Standard Dimensions for 15/8" (41.3mm) width series channel fittings (Unless Otherwise Shown on Drawing)
Hole Diameter: 9/16" (14.3mm); Hole Spacing - From End: 13/16" (20.6mm); Hole Spacing - On Center: 17/8" (47.6mm); Width: 15/8" (41.3mm); Thickness: 1/4" (6.4mm)

General Fittings

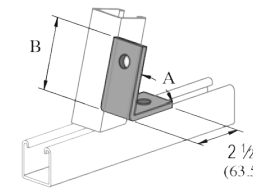

P1186 DF

Part Number	"A" in (mm)	"B" in (mm)
P1186 DF	45° (0.79)	3 1/8" (79.4)

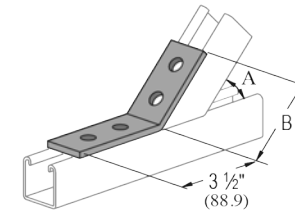

P2265 DF

Part Number	"A" in (mm)	"B" in (mm)
P2265 DF	45° (0.79)	3 1/16" (93.7)

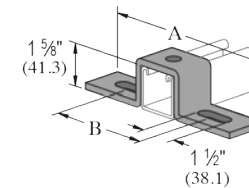

P1048 DF

Part Number	"A" in (mm)	"B" in (mm)	Wt/100 pcs lbs (kg)
P1048 DF	7 1/4 (184.2)	4 1/8" (104.8)	105 (47.6)

P1045 DF

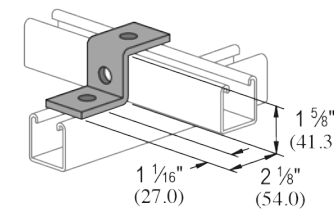

Wt/100 pcs: 55 lbs (24.9 kg)

P1047 DF

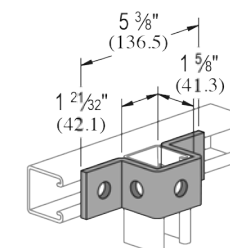

Wt/100 pcs: 88 lbs (39.9 kg)

P2072A DF, P2072A SQ DF

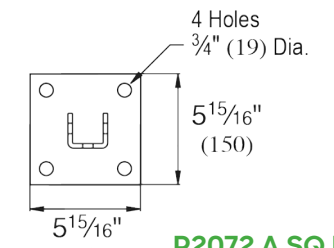
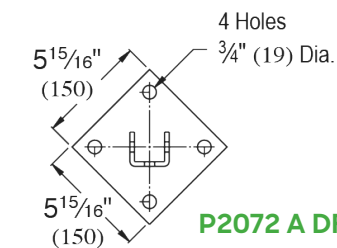
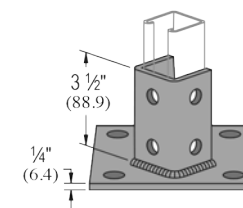

Wt/100 pcs: 373 lbs (169.2 kg)

Standard Dimensions for 15/8" (41.3mm) width series channel fittings (Unless Otherwise Shown on Drawing)
Hole Diameter: 9/16" (14.3mm); Hole Spacing - From End: 13/16" (20.6mm); Hole Spacing - On Center: 17/8" (47.6mm); Width: 15/8" (41.3mm); Thickness: 1/4" (6.4mm)



General Fittings

P1271S DF

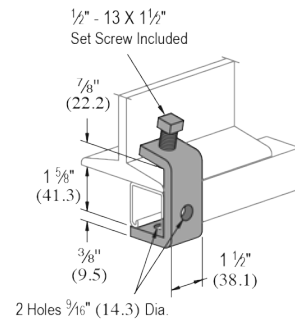

Wt/100 pcs: 95 lbs (43.1 kg)

Design Load Each
500 lbs (2.22 kN)
Use in Pairs Only

Note: Requires P1010
Channel Nut and bolt.

P2785 DF

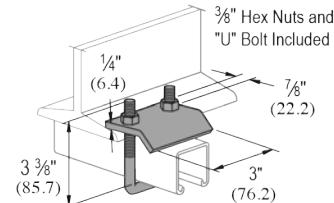

Wt/100 pcs: 83 lbs (37.6 kg)

Design Load Each
1,000 lbs (4.45 kN)
Use in Pairs Only

• For use with Beams
up to 3/4" (19.1) Flanges
and with Channels
P1000, P3300, P3301,
P4100, and P4101.

P2786 DF

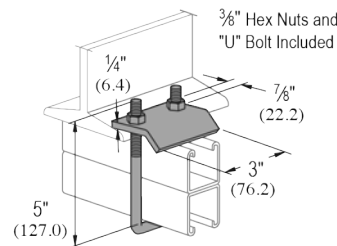

Wt/100 pcs: 92 lbs (41.7 kg)

Design Load Each
1,000 lbs (4.45 kN)
Use in Pairs Only

• For use with Beams
up to 3/4" (19.1) Flanges
and with Channels
P1001, P5000.

P2787 DF

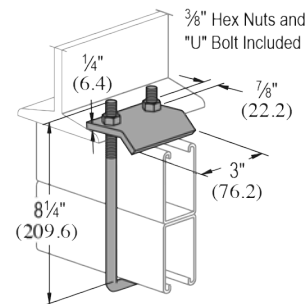

Wt/100 pcs: 112 lbs (50.8 kg)

Design Load Each
1,000 lbs (4.45 kN)
Use in Pairs Only

• For use with Beams
up to 3/4" (19.1) Flanges
and with Channels
P5001.

Beam Clamps

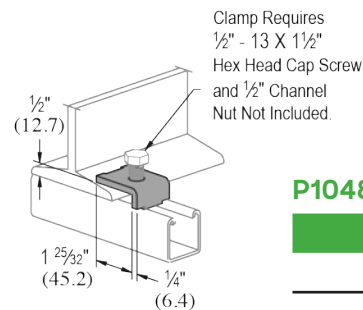

P1048 DF

Part Number	Design Load Each (Use in Pairs Only) lbs (kN)
P1000 DF	600 (2.67)

Wt/100 pcs: 27 lbs (12.2 kg)

Standard Dimensions for 1 5/8" (41.3mm) width series channel fittings (Unless Otherwise Shown on Drawing)
Hole Diameter: 9/16" (14.3mm); Hole Spacing - From End: 13/16" (20.6mm); Hole Spacing - On Center: 17/8" (47.6mm); Width: 1 5/8" (41.3mm); Thickness: 1/4" (6.4mm)
Note: When used for mechanical supports, load capacities of brackets and fittings should be in compliance with the American Standard Code for Pressure Piping.

Pipe/Conduit Clamps

P1428 DF THRU P1431 DF PIPE CLAMPS FOR THIN WALL CONDUIT (E.M.T.)

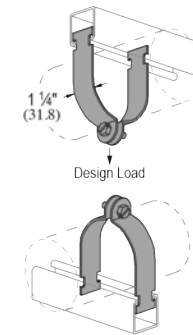

Part Number	Conduit Size in (mm)	O.D. Size in (mm)	Thickness Gauge (mm)	Wt/100 pcs lbs (kg)	Design Load lbs (kN)
P1428 DF	1 (25.4)	1.163 (29.5)	14 (1.9)	15 (6.8)	600 (2.67)
P1429 DF	1 1/4 (31.8)	1.510 (38.4)	14 (1.9)	18 (8.2)	600 (2.67)
P1430 DF	1 1/2 (38.1)	1.740 (44.2)	12 (2.7)	29 (13.2)	800 (3.56)
P1431 DF	2 (50.8)	2.197 (55.8)	12 (2.7)	33 (15.0)	800 (3.56)
P1118 DF	2 1/2 (63.5)	2.875 (73.0)	12 (2.7)	40 (18.1)	800 (3.56)
P1119 DF	3 (76.2)	3.500 (88.9)	12 (2.7)	47 (21.3)	800 (3.56)

Slotted hex head screw and nut included.

P1112 DF THRU P1119 DF PIPE CLAMPS FOR RIGID STEEL CONDUIT

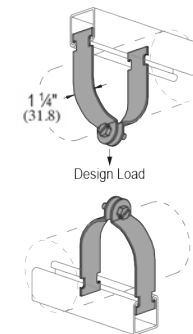

Part Number	Conduit Size in	O.D. Size in (mm)	Thickness Gauge (mm)	Wt/100 pcs lbs (kg)	Design Load lbs (kN)
P1112 DF	3/4	1.050 (26.7)	14 (1.9)	15 (6.8)	600 (2.67)
P1113 DF	1	1.315 (33.4)	14 (1.9)	17 (7.7)	600 (2.67)
P1114 DF	1 1/4	1.660 (42.2)	14 (1.9)	19 (8.6)	600 (2.67)
P1115 DF	1 1/2	1.900 (48.3)	12 (2.7)	29 (13.2)	800 (3.56)
P1117 DF	2	2.375 (60.3)	12 (2.7)	34 (15.4)	800 (3.56)
P1118 DF	2 1/2	2.875 (73.0)	12 (2.7)	40 (18.1)	800 (3.56)
P1119 DF	3	3.500 (88.9)	12 (2.7)	47 (21.3)	800 (3.56)

Slotted hex head screw and nut included.

P1214 DF THRU P1217 DF UNIVERSAL CLAMPS FOR RIGID OR THINWALL CONDUIT

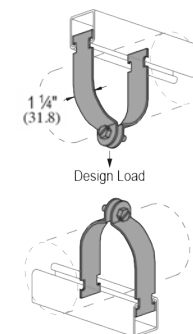

Part Number	Conduit Size in (mm)	Thickness Gauge (mm)	Wt/100 pcs lbs (kg)	Design Load lbs (kN)
P1214 DF	1 1/4 (31.8)	14 (1.9)	18 (8.2)	600 (2.67)
P1215 DF	1 1/2 (38.1)	14 (1.9)	20 (9.1)	600 (2.67)
P1217 DF	2 (50.8)	14 (1.9)	22 (10.0)	600 (2.67)

Slotted hex head screw and nut included.



HFLW025 DF 10	P1031 DF 13	P1430 DF 16
HFLW037 DF 10	P1036 DF 12	P1431 DF 16
HFLW050 DF 10	P1045 DF 14	P1498 DF 13
HHCS025075DF 10	P1047 DF 14	P1546 DF 13
HHCS025150DF 10	P1048 DF 14	P2072A DF 14
HHCS037100DF 10	P1063 DF 12	P2072ASQ DF 14
HHCS037150DF 10	P1064 DF 12	P2265 DF 14
HHCS050094DF 10	P1065 DF 12	P2324 DF 14
HHCS050119DF 10	P1066 DF 12	P2484 DF 13
HHCS050150DF 10	P1067 DF 12	P2785 DF 15
HHXN025 DF 10	P1068 DF 13	P2786 DF 15
HHXN037 DF 10	P1112 DF 16	P2787 DF 15
HHXN050 DF 10	P1113 DF 16	P2863 DF 12
HLKW025 DF 10	P1114 DF 16	P2864 DF 12
HLKW037 DF 10	P1115 DF 16	P3006-1420DF 6
HLKW050 DF 10	P1117 DF 16	P3008 DF 6
HRCN037 DF 10	P1118 DF 16	P3010 DF 6
HRCN050 DF 11	P1119 DF 16	P3013 DF 7
HTHR037 06DF 11	P1186 DF 14	P3300 DF 7
HTHR050 06DF 11	P1214 DF 16	P3300T DF 7
P1000 DF 6	P1215 DF 16	P4008 DF 7
P1001 DF 6	P1217 DF 16	P4010 DF 7
P1000T DF 6	P1271S DF 15	P4100 DF 8
P1001T DF 6	P1325 DF 13	P4100T DF 8
P1006-1420 DF 6	P1346 DF 13	P5000 DF 10
P1008 DF 6	P1380A DF 12	P5000T DF 10
P1010 DF 6	P1386 DF 15	P5508 DF 9
P1026 DF 13	P1428 DF 16	P5510 DF 9
P1028 DF 13	P1429 DF 16	

Atkore Defender™



Superior Corrosion Defense.





Allied Tube & Conduit ▲ AFC Cable Systems ▲ Heritage Plastics ▲ Cii ▲ Unistrut ▲ US Tray
Unistrut Construction ▲ Marco ▲ Calpipe Security ▲ Calbrite ▲ Calbond ▲ Flexicon ▲ Kaf-Tech
Power-Strut ▲ Calconduit ▲ FRE Composites ▲ United Poly Systems ▲ Sasco Strut ▲ Columbia-MBF
Elite Polymer Solutions ▲ Four Star Industries ▲ Eastern Wire + Conduit ▲ ACS/Uni-Fab ▲ Vergokan
Northwest Polymers ▲ Cascade Poly Pipe + Conduit ▲ Razor Ribbon ▲ Queen City Plastics ▲ Cope

Learn more at www.unistrut.us/atkore-defender